

Be Strong.™



 **NAUTILUS** Users Manual
NV 915 LCD Digital Monitor (NTSC)

FCC Information

FCC Information

This equipment has been tested and found to comply with limits for a class B digital device, pursuant to Part 15 of the FCC Rules. These limits are designed to provide reasonable protection against harmful interference in a residential installation.

This equipment can generate, uses, and radiates radio frequency energy and, if not installed and used in accordance with the instructions, may cause harmful interference to radio communications. However, there is no guarantee that interference will not occur in a particular installation.

If this equipment does cause unacceptable interference to radio and television reception, which can be determined by turning the equipment off and on, the user is encouraged to try to correct the interference by one or more of the following measures.

- Reorient or relocate the receiving antenna.
- Increase the separation between the equipment and receiver.
- Connect the equipment to an outlet on a circuit different from that to which the receiver is connected.
- Consult the dealer or an experienced Radio/TV technician for assistance.



ATTENTION

- Any changes or modifications in construction of this device which are not expressly approved by the party responsible for compliance could void the user's authority to operate the equipment.

Table of Contents

| | |
|--|-----------|
| Safety Precautions | 4 |
| Components | 5 |
| Product Specifications | 6 |
| Safety warning labels | 7 |
| Connections | 8 |
| Using Remote Control | 12 |
| LCD Menus | 14 |
| LCD Monitor Controls | 25 |
| Replacing Headphone Jack | 26 |
| Replacing Keypad | 27 |
| Troubleshooting | 29 |
| Warranty Terms | 30 |
| Important Contact Numbers | 31 |

Important Safety Precautions

IMPORTANT!

Save these instructions.

To reduce the risk of fire, electrical shock or other injuries, follow these safety precautions when installing, using and maintaining your NV915 LCD TV Monitor.

Read all instructions before using.



WARNING



This symbol appearing throughout this manual means: Pay Attention! Be Alert! Your Safety Is Involved!



WARNING

- Always disconnect the power before installing or servicing the equipment.
- Disconnect the power cable and signal cable when thunder or lightning is present.
- Do not touch the power cord with wet hands. Make sure the electrical connectors are clean and dry before use.
- Disconnect the power cord when not in use for extended periods of time.
- Do not use if power cord is damaged.
- Do not install LCD Monitor close to heating sources.
- Do not place heavy articles on, or step on the LCD Monitor.
- The product should be installed in a clean and dry place.
- If you detect any smoke, unusual noise or smell, disconnect the electric power and contact service.
- Avoid contact with liquids or beverages.
- Do not use or place any combustible or flammable substances close to the LCD Monitor.
- Do not place the power cord close to any heating devices/sources.
- Do not apply any twisting forces or excess pressure to the LCD Monitor.
- Do not attempt to disassemble, repair or modify the LCD Monitor. If the LCD Monitor needs repair or adjustment, refer servicing to qualified service personnel.
- When cleaning, do not directly spray with water or use flammable substances.
- Do not allow liquids to penetrate the LCD Monitor.
- When cleaning the LCD Monitor, disconnect the power and use a clean soft cloth. Never use a wet cloth.



ATTENTION

- Any changes or modifications in construction of this device which are not expressly approved by the party responsible for compliance could void the users authority to operate the equipment.

Components

Please make sure the following items are included with your order.

If any items are missing, please contact Customer Service.

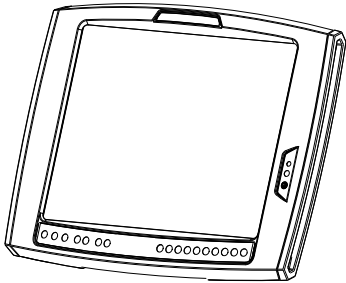

LCD Monitor/Monitors
Part # **002-3782**

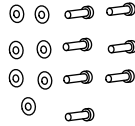

Hardware Kit
Part # 001-1938

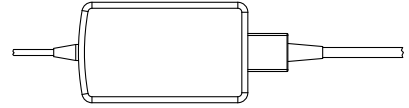

Power Supply
Part # **002-3787**



Power Cord
Part # 001-1922



Owners Manual CD
Part # 001-7167

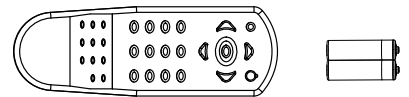

Remote Control with Batteries
002-3785
(Boxed Separately)

NV915 Product Specifications

NV915 LCDTV Monitor

Gross Weight: 13.0 lbs/ 5.9 kg
Net Weight: 9.9 lb/ 4.5 kg
Product Dimensions: 35.6cm (L) x 3.56cm (W) x 32.3cm (H)
14.0" (L) x 1.4" (W) x 12.7" (H)

Optional Accessories

M-Series Bracket

Gross Weight: 8.0 lbs/ 3.63 kg
Net Weight: 4.75 lb/ 2.15 kg
Product Dimensions: 49cm (L) x 17cm (W) x 43cm (H)
19.3" (L) x 6.7" (W) x 16.9" (H)

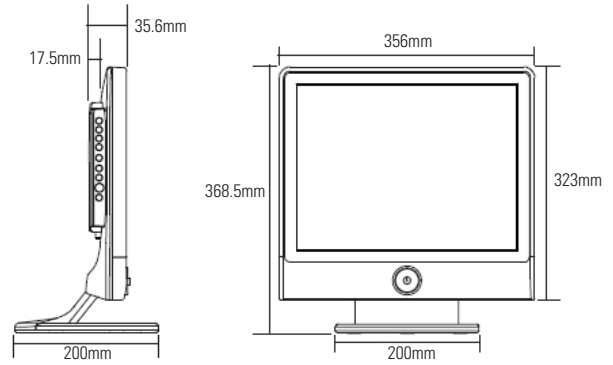

T-Series Bracket

Gross Weight: 10 lbs/ 4.5 kg
Net Weight: 6.75 lb/ 3.1 kg
Product Dimensions: 49cm (L) x 17cm (W) x 43cm (H)
9.3" (L) x 6.7" (W) x 16.9" (H)

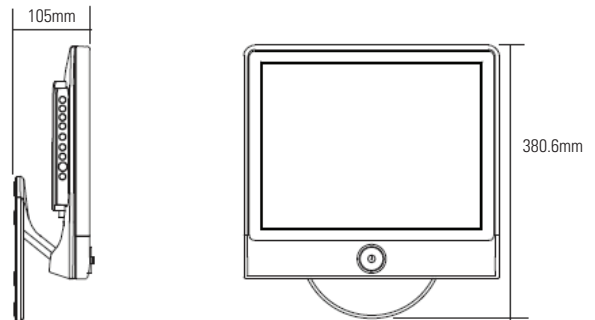

Power Requirements:

Adaptor Input: 100-240V AC, 50-60Hz
Adaptor Output: DC 12V, 3.33A

Regulatory Information:

FCC:

This device complies with Part 15 of the FCC and the Canadian ICES-003 regulations for Class A apparatus. Operations is subject to the following two conditions:

- (1). This device may not cause harmful Interferences and
- (2). This device must accept any interference received, including interference that may cause undesired operation.



The LCDTV Monitor NV915-000N Model bears the CSA Mark shown with adjacent indicators 'C' and 'US'



The LCDTV Monitor with PAL tuner bears the CE Mark and meets all safety and EMC requirements required by the European Union and Australia / New Zealand.



For Customers in the European Union, Do not dispose of this product as refuse. This product is to be recycled. For information on the proper method of disposal contact a Nautilus, Inc. Customer Service Representative. Contact information is available in the Important Contact Numbers section in this manual.

The LCDTV Monitor with PAL tuner is RoHS compliant.

Safety Warning Labels

The following safety warnings are located on the NV915 LCD Monitor.
Please read all safety precautions and warning information prior to using your product.

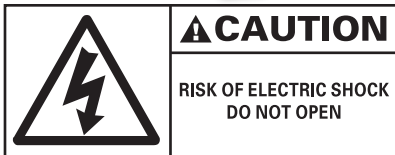

Connections

Rear Connection Panel

- ① DTV / Analog TV Antenna Input
- ② SPDIF (ATSC) Out
- ③ HDMI Input
- ④ PC Input
- ⑤ PC Audio Input / Headphone Output
- ⑥ Power Input

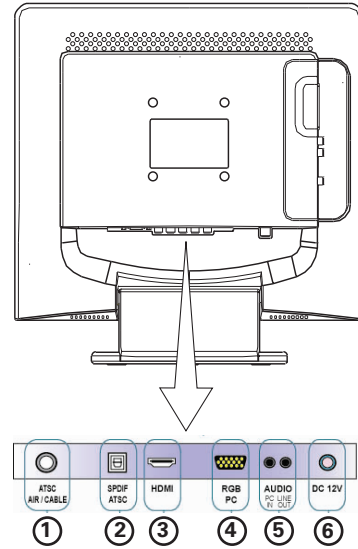

Side Connection Panel

(LCD Monitor Back Cover must be removed to access Side Panel)

- ⑦ Component Input (Video/Audio)
- ⑧ Audio L/R Input
- ⑨ S-Video Input
- ⑩ Video Input

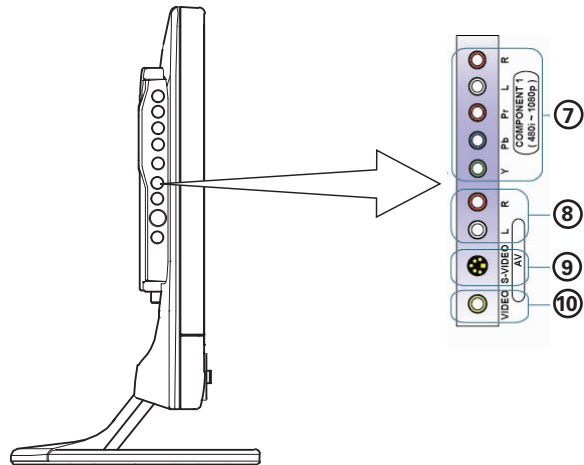

Front Connection Panel

- ⑪ Audio (Headphone Output)

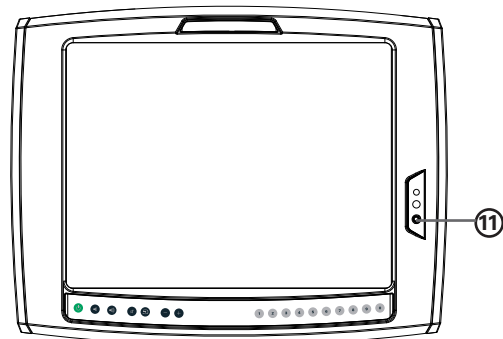

Connections

Connecting Antenna

NOTE: When using Coaxial Cable, make sure the Copper Wire is not bent.

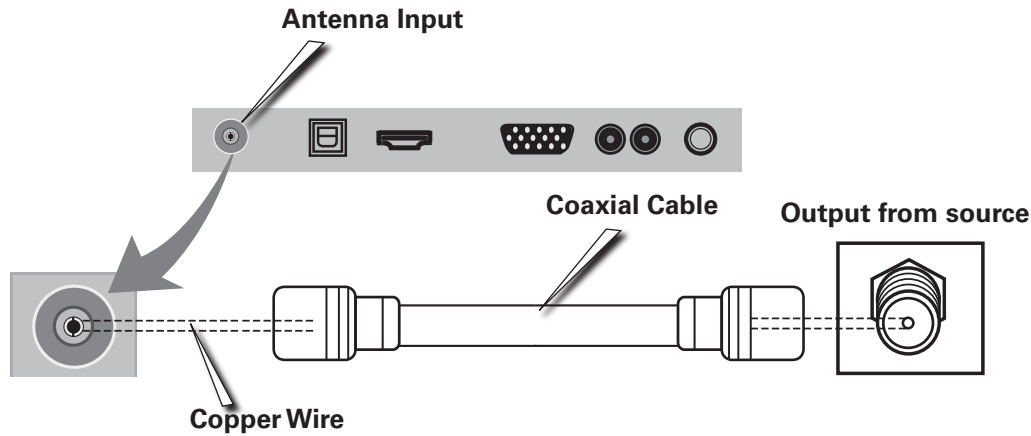

Connecting PC

1. Connect D-Sub Cable (not included) to the D-Sub port on the LCD Monitor and PC.
2. Connect Audio Cable (not included) to Audio output of PC and the Audio Input of the LCD Monitor.

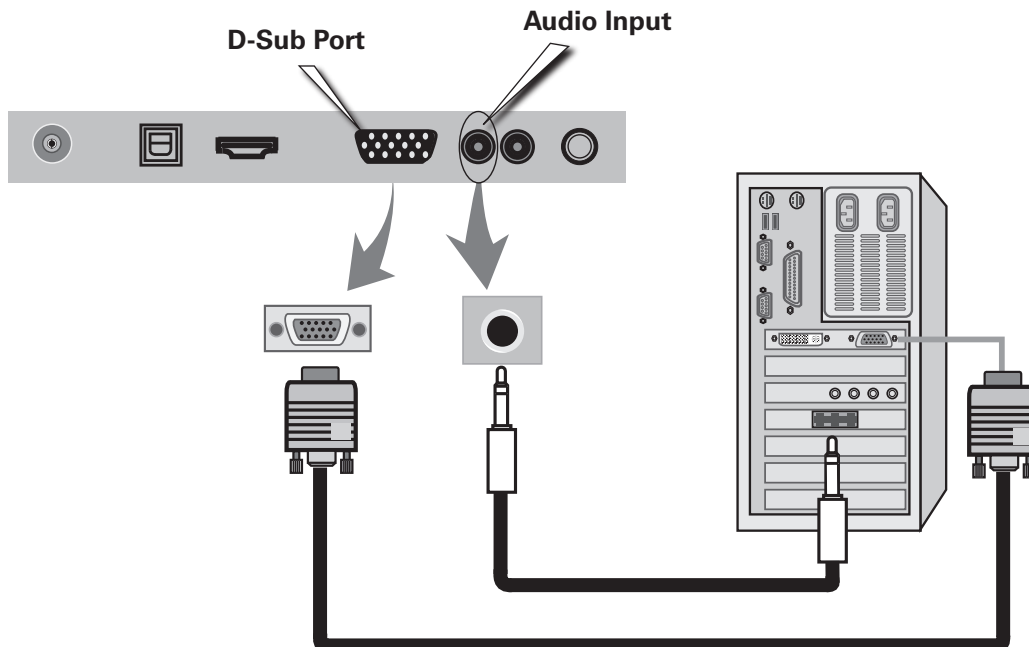

Connections

Connecting DTV (digital), DVD (Pb Y Pr), VCR, Set Top Box or Camcorder.

NOTE: LCD Back Cover must be removed to access Side Panel. Cables must be connected to ports of the same color.

1. Connect Component Cable (not included) to the Connection ports on the LCD Monitor and DTV Receiver, DVD Player, VCR, Set Top Box or Camcorder.
2. Connect Audio Cable (not included) to Audio ports of the LCD Monitor and DTV Receiver, DVD Player, VCR, Set Top Box or Camcorder.

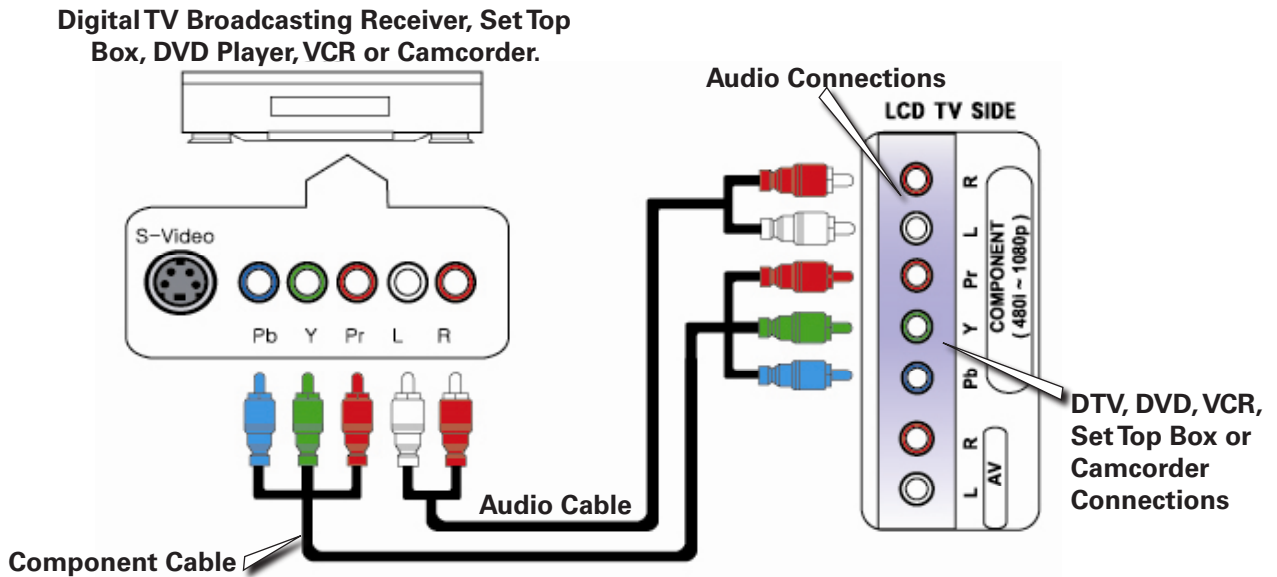

Connecting Video/S-Video Input

NOTE: LCD Back Cover must be removed to access Side Panel. Cables must be connected to ports of the same color.

1. Connect Video/Audio Cable (not included) and S-Video Cable (not included) to Video port of LCD Monitor and Camcorder, VCR, DVD Player, or Set Top Box.

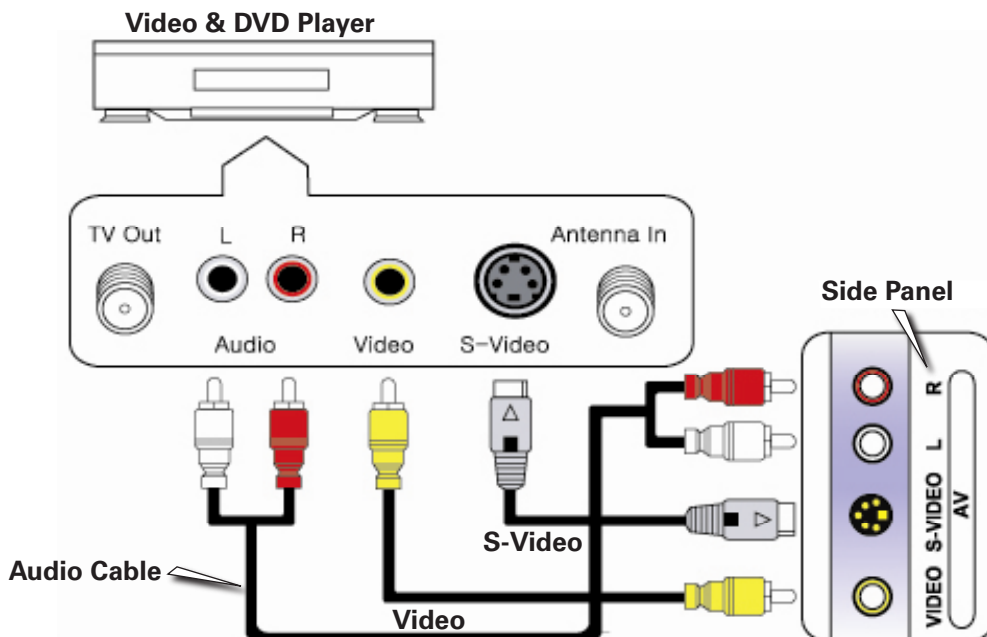

Connections

Connecting HDMI

1. Connect HDMI cable to HDMI ports of TV and DVD player, VCR, Set-Top box or camcorder.
2. If you would like to connect DVI of external equipment to the TV, you must use specific DVI to HDMI cable.

NOTE: HDMI and audio cables are not included.

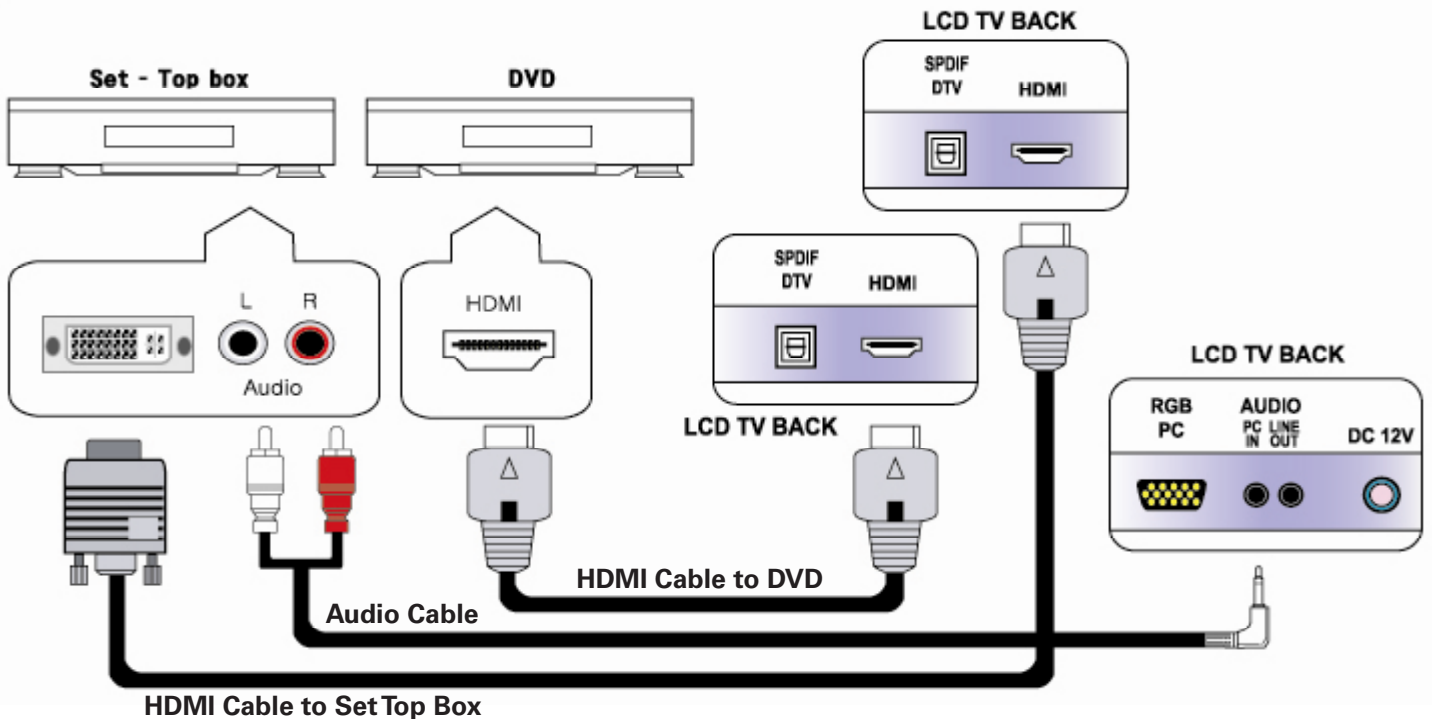

Connecting Headphone

1. Connect headphone or external speaker (**not included**) to the Headphone output port of the TV.
2. Please use 8ohms impedance headphone. Otherwise output volume may be too low or too loud.
3. In case of connecting to speakers, connect speakers with amps. If connected with speakers without amps, the output volume may be low.

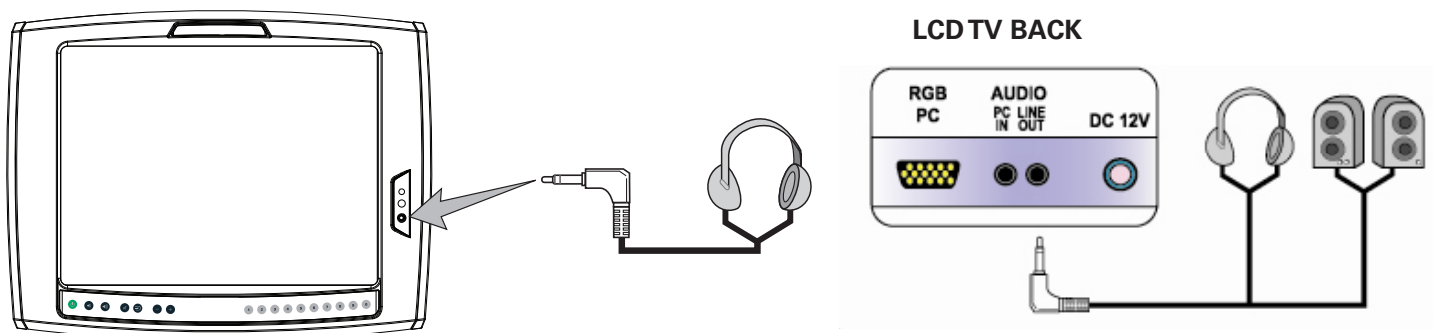

Headphone Jack or External Speakers

Using Remote Control

Remote Control Buttons

- 1 Power On/Off
- 2 Sound Off
- 3 Channel Selection
- 4 TV & Input Source
- 5 Control Sound Mode
- 6 Control Picture Mode
- 7 Volume Control
- 8 Channel Control
- 9 Menu
- 10 Caption On/Off
- 11 TV Functions (Hot Key)
- 12 Still Image (Freeze)
- 13 Electronic Program Guide
- 14 Not Available

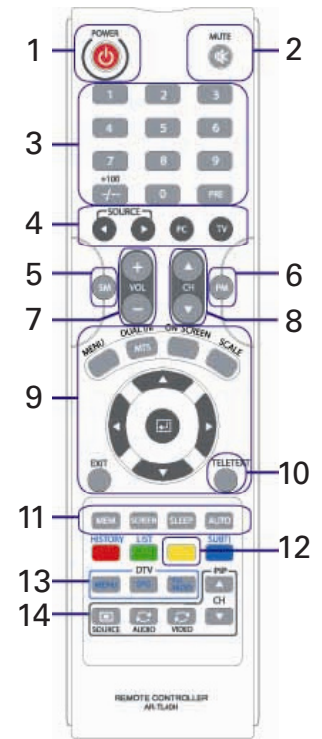

Remote Control Button Functions

| Button | Function | Button | Function |
|-----------------------|--|----------------------|---|
| POWER | Power On/Off | MUTE | Power On/Off |
| 0 ~ 9 | Numeric Buttons | +100, -/-- | TV: Channel input (cable) for over CH 99 DTV: Hyphen for Digital channel |
| PRE | Previous Channel | | |
| VOL + - | Set the volume | CH ▲▼ | Select the channel |
| SOURCE | Select the Input Source (TV → DTV → VIDEO → S-VIDEO → RGB → HDMI → COMPONENT) | | |
| PC | Select PC | TV | Select TV/DTV |
| SM | Select Sound Mode (Standard → Music → Movie → News → User) | | |
| PM | Select Picture Mode (Standard → Soft → Dynamic → Movie1 → Movie2 → User) | | |
| MENU | Display the Menu Screen | | |
| MTS | Change MTS to match the television broadcast signal for TV/DTV | | |
| ON SCREEN | Display the current channel (or input source) information on the screen | | |
| SCALE | Select the screen size | | |
| ◀/▶/▲/▼/↵ | Select a desired item on the screen | | |
| EXIT | Exit Menu | | |
| TELETEXT | Caption ON/OFF | MEM | Add/Remove TV Channel |
| SCREEN | Not Available | | |
| SLEEP | Sleep Timer setting (Off - 180 minutes) | | |
| AUTO | Auto Adjustment for PC input source only | | |
| Red Button | Not Available | Green Button | Not Available |
| Blue Button | Not Available | Yellow Button | Set the still image |
| DTV (MENU) | Not Available | DTV (EPG) | DTV EPG: Not Available |
| DTV (TV/RADIO) | Not Available | | |
| PIP (CH ▲▼) | Not Available | PIP (SOURCE) | Not Available |
| PIP (AUDIO) | Not Available | PIP (VIDEO) | Not Available |

Using Remote Control

MENU Configuration

Most functions of the TV set can be controlled by MENU and selection buttons on the remote control, so learning how to operate them would be convenient for you.

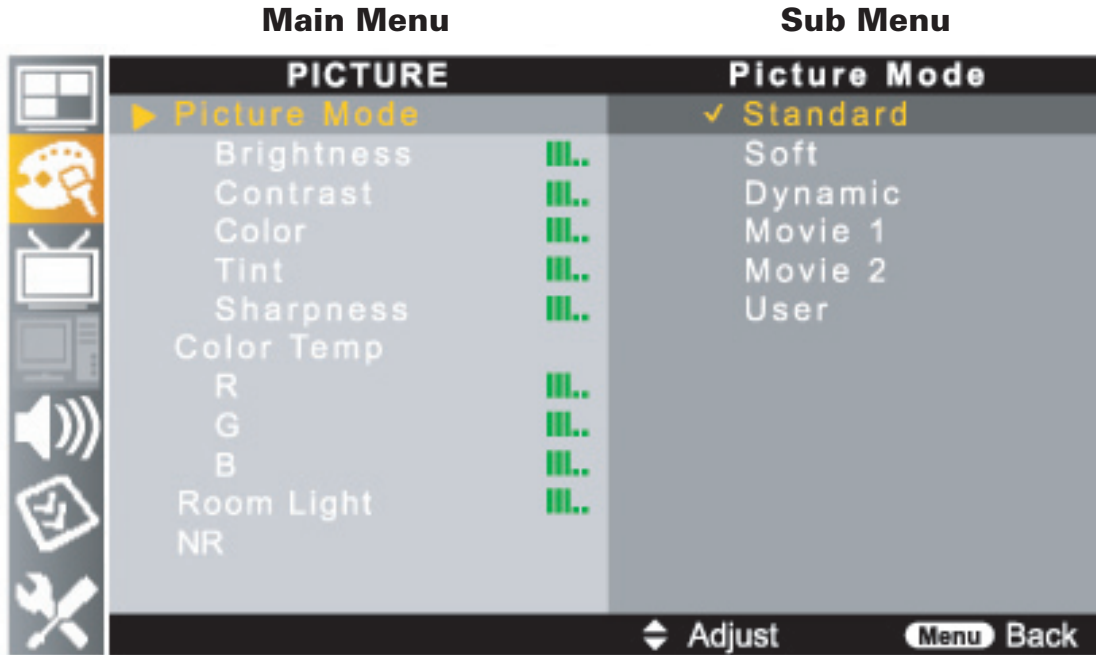

Using Remote Control



- Press MENU button on the remote control to display main menu.
- Press Menu control button (▶) to move to sub menu of a selected main menu.
- Press EXIT button to turn off the menu screen.
- To move among menus, use Menu control buttons (▲/▼).
- To change a selected menu setting, use Menu control buttons (▲/▼).

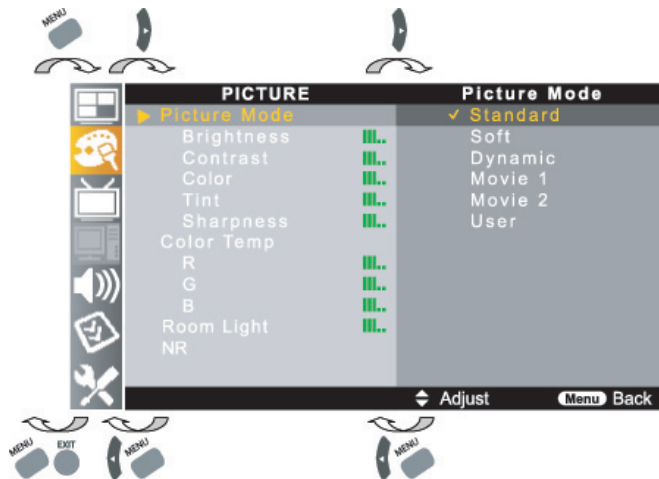

LCD Menus

MENU Configuration

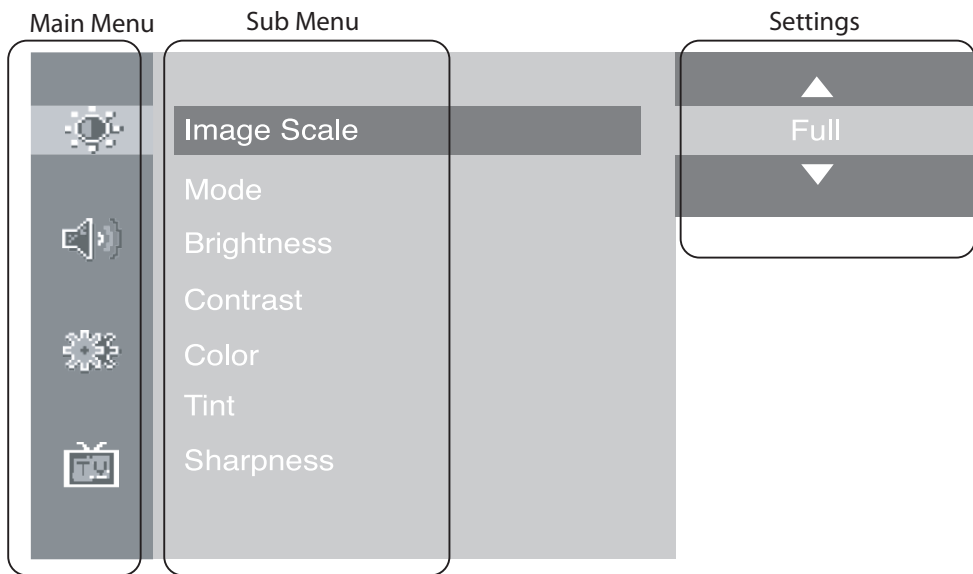

Channel Search

When using the LCD Monitor after first connection, reconnection due to power failure or other reasons, channels should be searched and registered.

- Press **AUTO** button on the remote control.
- To start the channel search, navigate to Start by using the **VOL** button.
- Press **MENU** button to stop the search.
- If you stop during the channel search, only the currently searched channels will be stored.

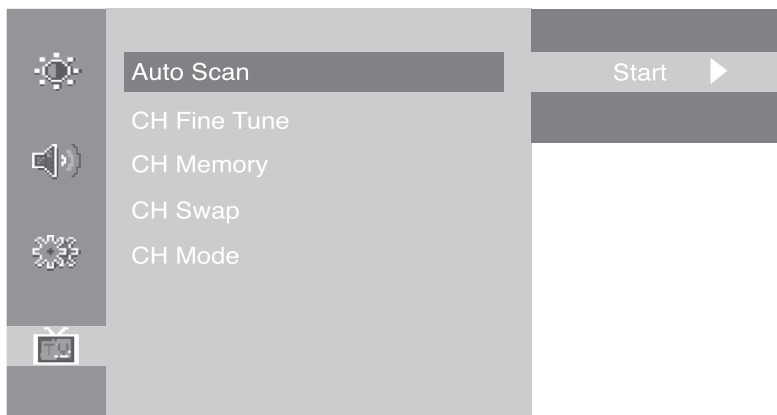

LCD Menus

Fine Tune

Use the Fine Tune function if a searched channel is unclear or has abnormal sound.

- Press **MENU** button and navigate to <Ch Fine Tune> menu.
- Find the best reception with the **CH** button.
- Press **MENU** button to stop the search.

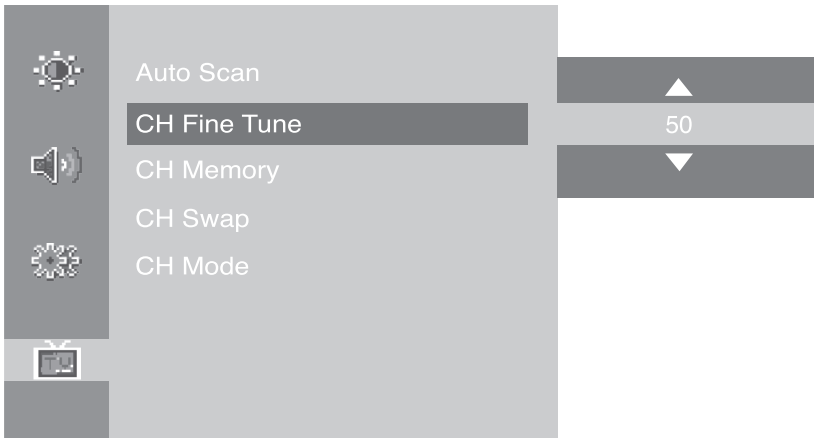

Add/Remove Channel

You may add or remove channels as needed.

- Use the numeric buttons (0-9) or the **CH** button to select a channel.
- Press the **MEMORY** button.
- If adding a channel by using the **CH** button, move to Add.
- Once the setting is complete, press the **MEMORY** button again.



MEMORY

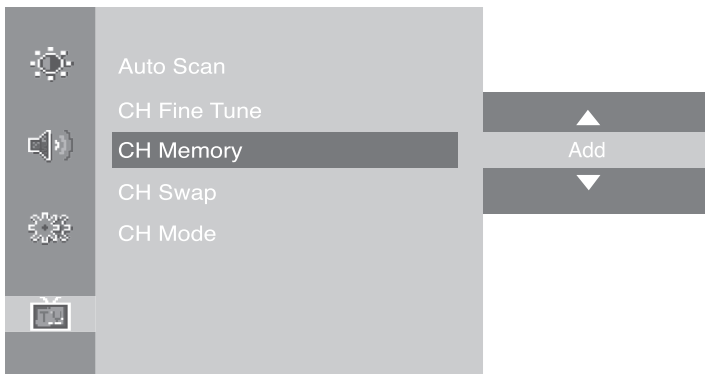

LCD Menus

Add/Remove Channel

Frequently watched channels can be swapped and stored with other channels.

- Navigate to the channel you wish to swap.
- Press the **MENU** button and navigate to the <CH Swap> menu.
- Set both channels that you want to swap.
- Change the default and escape the menu.

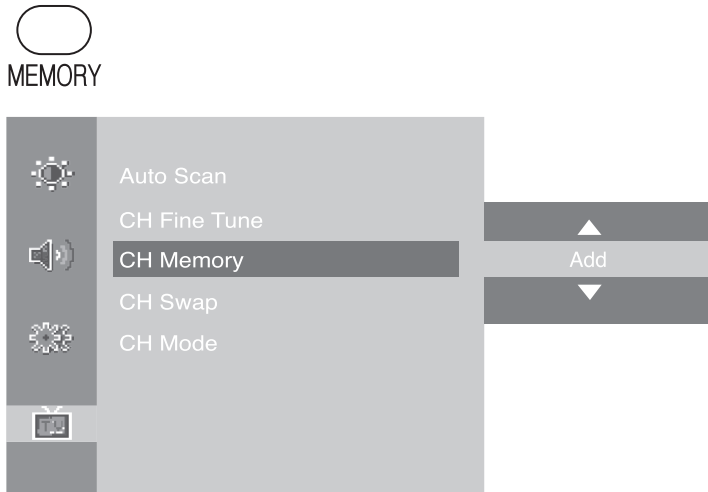

Change TV Channel Mode

Choose between **Air** or **Cable** for broadcast type.

- Press **MENU** button and navigate to <Ch Mode> menu.
- Use the **CH** button to select Air or Cable mode.
- Press the **MENU** button to complete the selection.

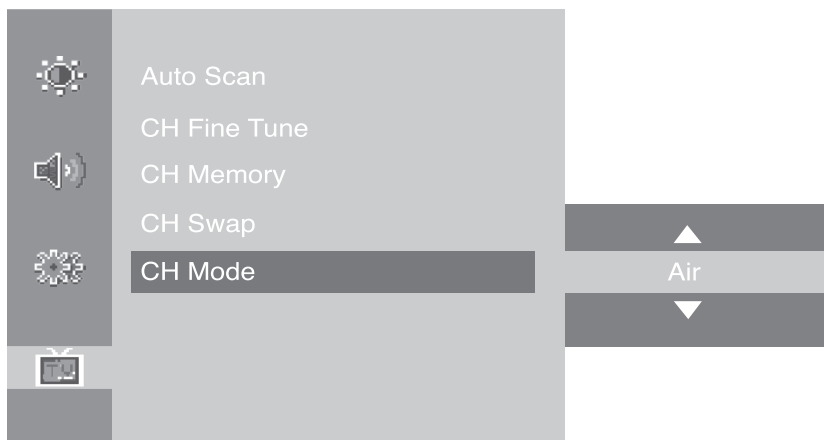

LCD Menus

Closed Caption

Closed Caption function allows you to view conversations, narration and sound effects as subtitles on your TV. It is available on some TV programs and on some VHS home video tapes at the discretion of the program provider. Digital Closed Caption service is a new caption service available only on digital TV programs (also at the discretion of the service provider). It is more flexible system than the original Closed Caption system, because it allows a variety of caption sizes and font styles. Not all programs and VHS videotapes offer closed captions. Please look for the <CC> symbol to ensure that captions will be shown.



1. Closed Caption Setup

Press TELETEXT button on the remote control to select desired caption mode. Select caption mode as follows;

- Analog : Off – CC1 – CC2 – CC3 – CC4 – Text1 – Text 2 – Text 3 – Text4
- Digital : Off - English - Spanish - French

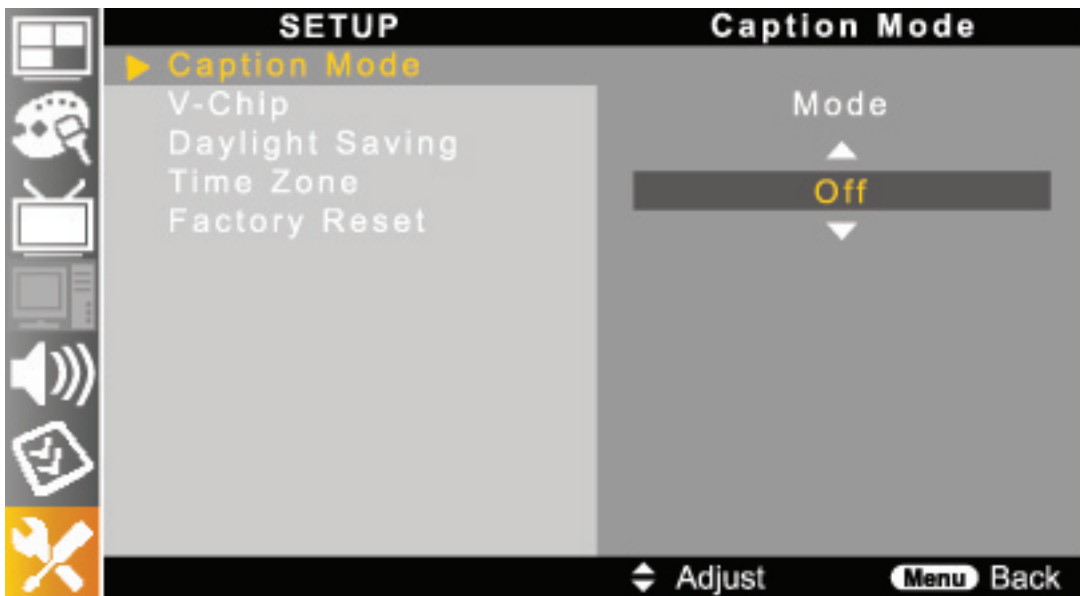

2. Font Setting (Digital Closed Caption only)

This function allows you to adjust the digital closed caption screen appearance to suit your preference.

- Press MENU button on the remote control and move to <SETUP – Caption Mode> and execute caption.
- Press ◀/▶/▲/▼ buttons to move to <SETUP – Font Option> and press the ↵ button.

LCD Menus

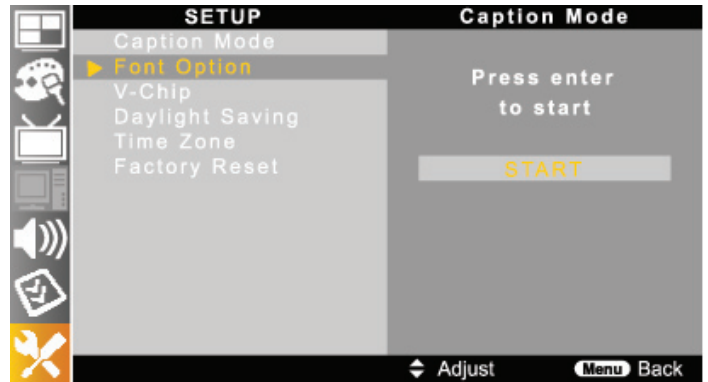
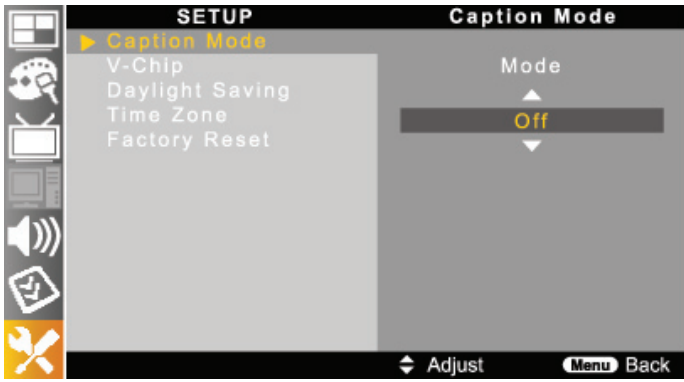

- Press ◀/▶/▲/▼ buttons to select digital closed caption screen appearance.
- Press EXIT button to return to the normal screen.

| Menu | Description | Item |
|---------------------------|-------------------------|--|
| Size | Font Size | Standard - Large - Small |
| Style | Font Style | Style0 ~ Style 7 |
| Background Color | Font background color | (White) — Black — Red — Green — Blue — Yellow — Magenta — Cyan |
| Foreground Color | Font color | White — (Black) — Red — Green — Blue — Yellow — Magenta — Cyan |
| Edge Color | Edge table color | White — Black — Red — Green — Blue — Yellow — Magenta — Cyan |
| Background Opacity | Font background opacity | Solid — Flashing — Translucent |
| Foreground Opacity | Font color opacity | Solid — Flashing — Translucent — Transparent |
| Edge Style | Edge table style | Style0 ~ Style 5 |

- Select different color of “Background Color” and “Foreground Color”

V-Chip Function

Parental Control can be used to block specific channels, ratings and other viewing sources.

The Parental Control Function (V-Chip) is used to block program viewing based on the ratings sent by the broadcasting station. The default setting is to allow all

LCD Menus

programs to be viewed. Viewing can be blocked by choosing the type of the program and the categories. It is also possible to block all programs viewing for a time period. To use this function, the following must be done:

1. Set ratings and categories to be blocked.
2. Specify a password
3. Enable the lock

1. V-Chip rating and categories

Rating guidelines are provided by broadcasting stations. Most television programs and television movies can be blocked by TV Rating and/or Individual Categories. Movies that have been shown at the theaters or direct-to-video movies use the Movie Rating System (MPAA) only.

2. Ratings for Television programs including made-for-TV movies :

- TV-G (General audience)
- TV-14 (Parents strongly cautioned)
- TV-Y (All children)
- TV-PG (Parental guidance suggested)
- TV-MA (Mature audience only)
- TV-Y7 (Children 7 years older)

3. Personal Identification Number (PIN) Setup

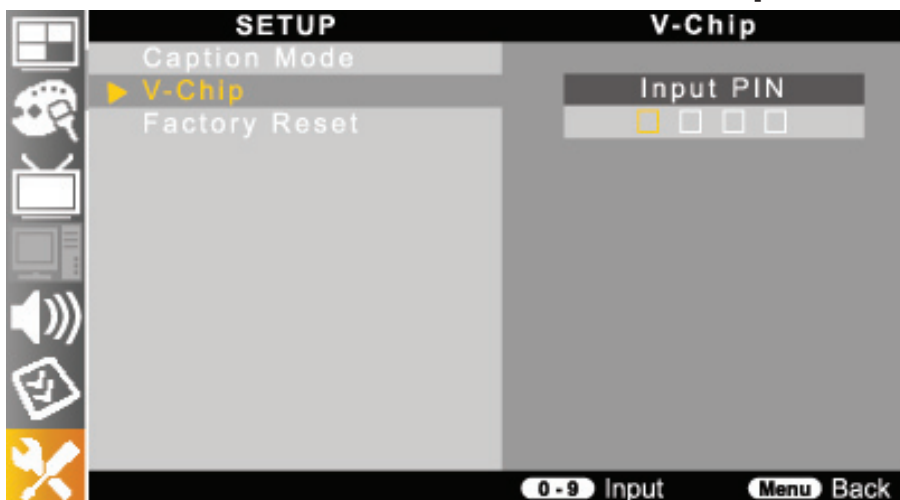

- Press the MENU button.
- Press the ◀/▶ / ▲/▼ buttons to move to <V-Chip>.
- The message <Input PIN> will appear. Enter your 4 digit PIN number. The <V-Chip> screen will appear.
- Press the ▲/▼ buttons to move to <Change PIN> and press the ◀ button. The Change PIN screen will appear. Choose any 4 digits for your PIN and enter them. The default PIN number for a new TV set is <0-0-0-0>. The <Confirm PIN> screen appears.
- Re-enter the same 4 digits. When the Confirm screen disappears, your PIN has been memorized.

LCD Menus

* Press the **(EXIT)** button to return to the normal screen.



4. How to Enable / Disable the V-Chip function

Press the **(MENU)** button.

Press the (**</>** / **▲/▼**) buttons to move to <V-Chip>.

The message <Input PIN> will appear. Enter your 4 digit PIN number.

The <V-Chip> screen will appear.

To enable the V-Chip feature, press the **▲/▼** buttons to move to <On>.

Press the **(EXIT)** button to return to the normal screen.

5. How to Setup Restrictions

Press the **(MENU)** button.

Press the (**</>** / **▲/▼**) buttons to move to <V-Chip>, then press the **↓** button.

The message <Input PIN> will appear. Enter your 4 digit PIN number.

The <V-Chip> screen will appear.

You can independently lock the ratings. The blocked ratings are indicated by a **<🔒>**.

Press the (**▲/▼**) buttons and the **↓** button to activate the appropriate restrictions for the selected rating system.

Press the **(EXIT)** button to return to the normal screen.

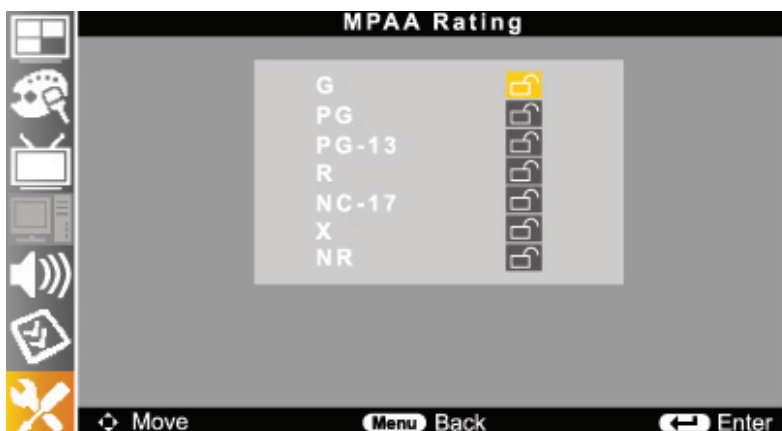

LCD Menus

Picture Mode

1. Picture Mode Setting

Adjust the picture to your preference with the following picture settings.

- Press **(MENU)** button on the remote control.
- Press (**◀/▶/▲/▼**) buttons to move <PICTURE – Picture Mode>.
- Select your preference picture mode by pressing **▲/▼** buttons.
Toggle : Standard – Soft – Dynamic – Movie1 – Movie2
- Also, it can be set by pressing **(PM)** button on the remote control.

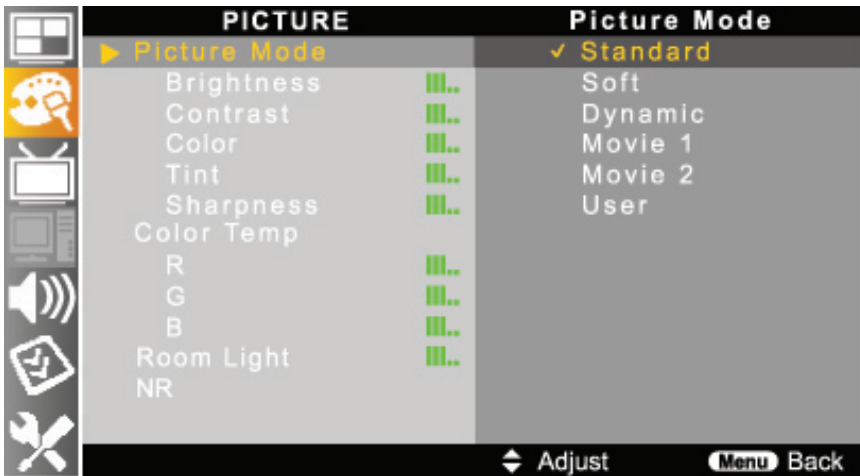

| Mode | Description |
|----------|--|
| Standard | This mode is standard picture mode to watch the TV. |
| Soft | Soft picture mode is set to watch TV or Film when screen is too bright for a dark room. |
| Dynamic | This is sharp picture mode to watch the TV in bright room. |
| Movie1 | This mode is better to watch bright screen picture. |
| Movie2 | This mode is better to watch dark screen picture. |
| User | This mode allows you to set to your preference status by controlling each item within the User setting by pressing ▲/▼ buttons. |

2. Picture Mode - <User> Settings

| User | Item | Description |
|------|------------|--|
| | Brightness | Adjust screen brightness. |
| | Contrast | Adjust screen contrast. |
| | Color | Adjust screen color. |
| | Tint | Adjust screen tint. If its level is close to red 50, skin tones become reddish. If its level is close to green 50, skin tones become greenish. |

(Continued on next page)

LCD Menus

2. Picture Mode - <User> Settings (Cont.)

| User | Item | Description |
|------|-------------------------|---|
| | Sharpness | Adjust screen sharpness. Level adjust between 0 (Min) to 100 (Max). |
| | Color Temp | Adjust screen color temperature to be natural. |
| | R G B | Adjust color temperature to the desired level. |
| | Room Light | Adjust screen brightness dependent on room brightness. |
| | NR (Noise Reduction) | If the broadcast signal received by your TV is weak, you can activate the Digital Noise Reduction feature to help reduce any static and ghosting that may appear on the screen. |

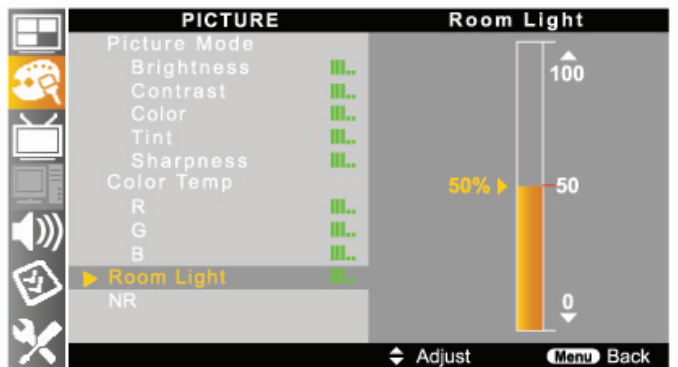
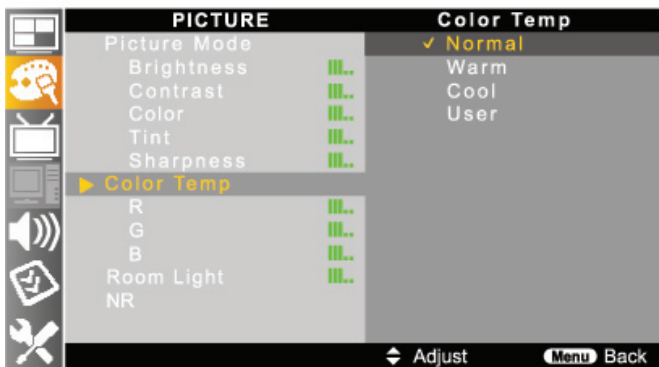
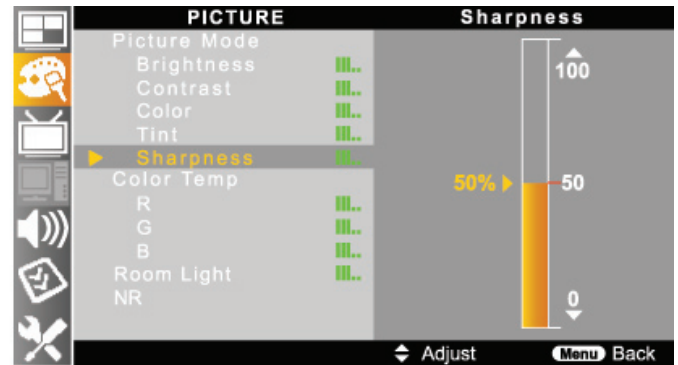
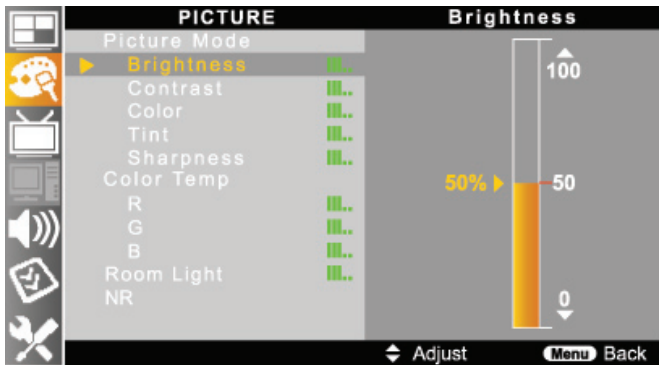

Timer Settings

Sleep timer

This function allows you to have the TV automatically turn off at a predetermined time.



- Press **(SLEEP)** button and navigate to main menu.
- Press **(▲ / ▼)** buttons to set to your desired predetermined turn off time.

LCD Menus

Toggle : Off ~ 180minutes

- Also, it can be set by JOG (OSD) button on the TV or (MENU) button on the remote control.



- This function is automatically erased if you turn off the TV before turning off the sleep timer setting.

Sound Mode

Sound Mode settings

Sound Mode setting allows you to select your desired sound mode.



- Press (SM) button on the remote control.
- Each press of this button, sound mode toggles <Standard → Music → Movie → News → User>.
- Also, it can be selected by pressing (MENU) button on the remote control.

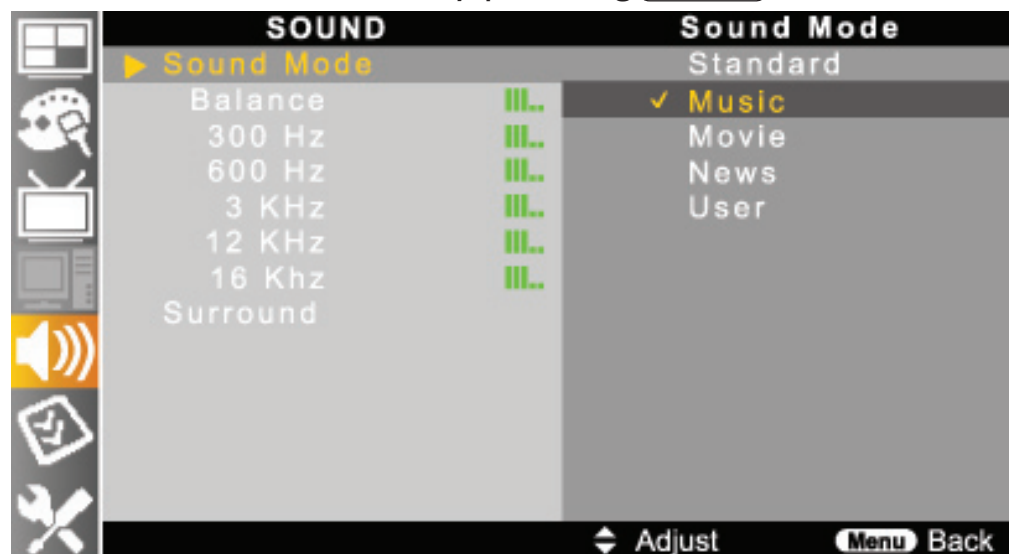

LCD Menus

| Mode | Description |
|----------|---|
| Standard | This mode is standard sound mode to watch the TV generally. |
| Music | This mode is better to watch a music program. |
| Movie | This mode is better to watch a movie program. |
| News | This mode is better to watch a news program. |
| Surround | The surround sound feature expands the audio listening field wider and deeper to create exceptional sound quality from the TV's speakers. |
| User | This mode allows you to set to your preference status by controlling each item within the User setting by pressing ▲ / ▼ buttons. |

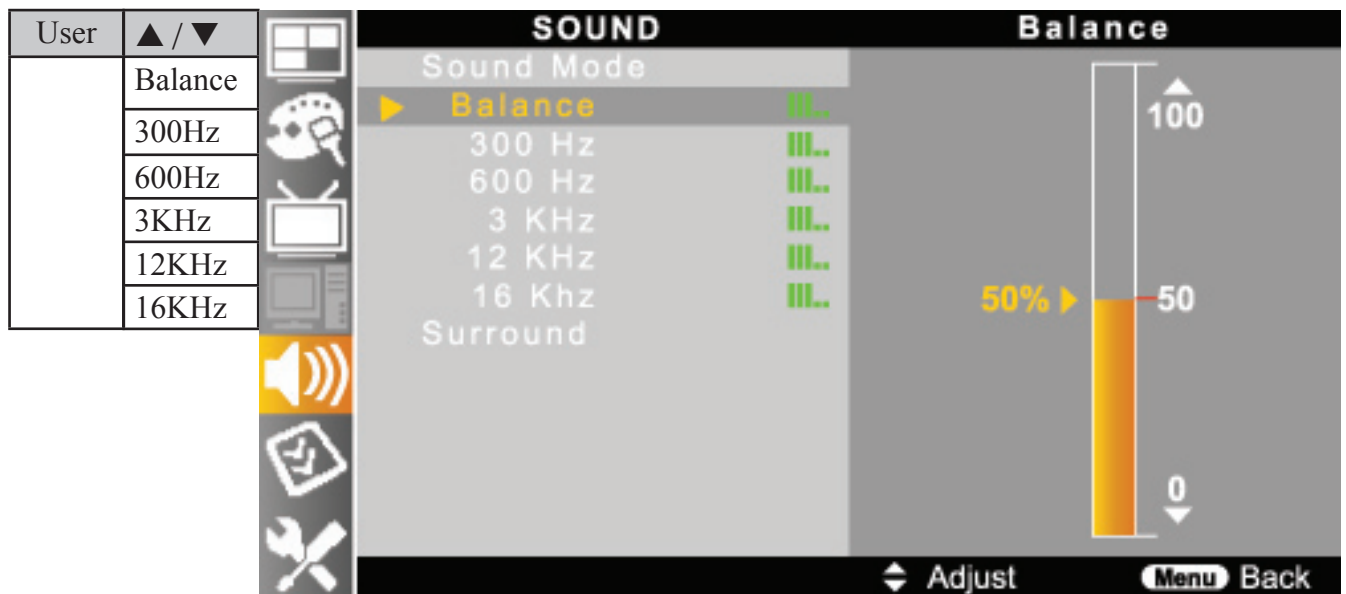

- Change each item (Balance, 300Hz, 600Hz, 3KHz, 12KHz and 16KHz) to your desired level.

PC Functions

Please check following steps before connecting a PC [OPTIMAL RESOLUTION: 1024 X 768 @ 60hZ].

- Refer to the Standard Signal Modes for PC Monitor.
- Make sure to select the same signal values for the output signal of a PC and the input of the TV before connecting with the PC. Depending on the PC being used, images may not be shown without converting the output signals into external output.
- Please refer to your PC's manuals regarding converting to external output.
- To protect equipment, always turn off the TV before connecting the PC.
- Connect the RGB cable making sure that it fits correctly into the PC terminal. Then, firmly secure the connectors by tightening the hexagonal nuts on both sides of the plug.
- Make sure its connection mode is <PC – RGB> on the menu.

LCD Monitor Controls

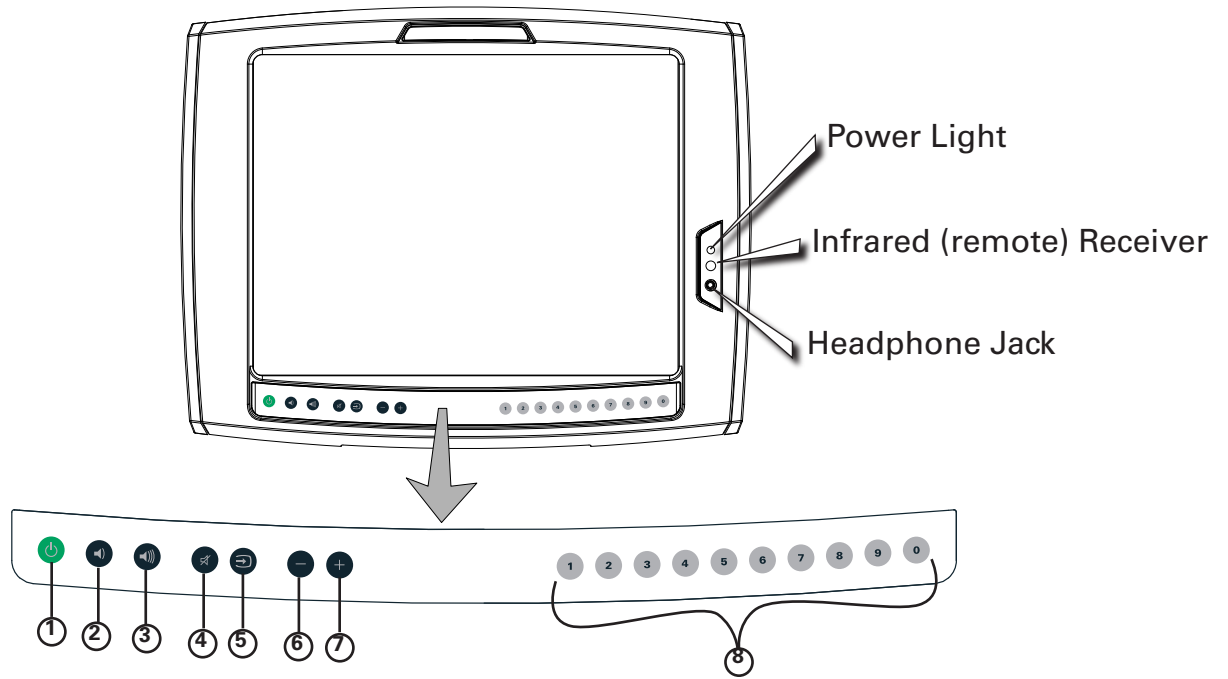

- ① Power
- ② Volume Down
- ③ Volume UP
- ④ Mute
- ⑤ Video Input Source (Video/S-Video, Antenna)
- ⑥ Channel Down
- ⑦ Channel Up
- ⑧ Numeric Channel Keys

Replacing Headphone Jack

Over time the Headphone Jack may become worn and fail to function properly.

Replacing Headphone Jack

Tools Needed:

Phillips Head Screwdriver

Parts Needed:

Headphone Jack Kit Part# 001-1945

1. Remove the Decal covering the Headphone Jack. (Figure A)
2. Use a Phillips Head Screwdriver to remove the two screws securing the jack.(Figure B)
3. Carefully remove the Headphone Jack from the LCD Monitor (Figure C) and disconnect the wires. (Figure D)
4. Reverse the procedure to install the jack.



Figure A

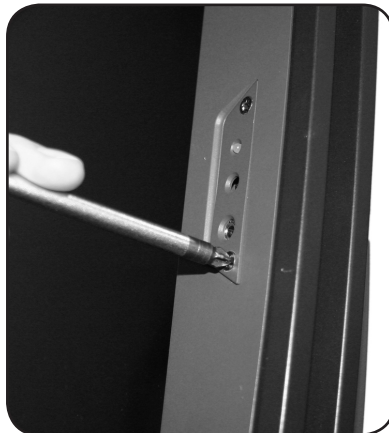

Figure B



Figure C

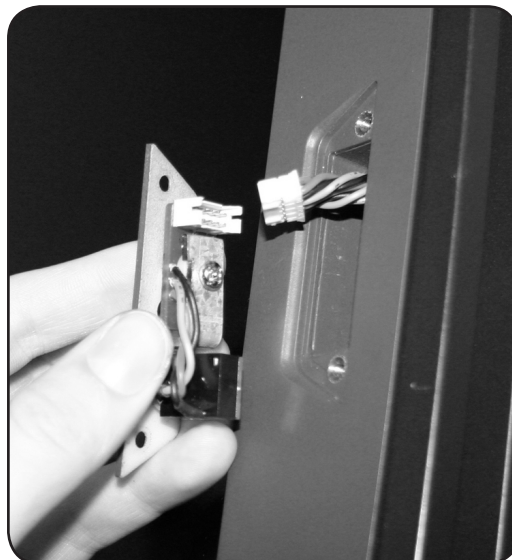

Figure D

Replacing Keypad

Over time the Keypad may become worn and fail to function properly.

Replacing Keypad

Tools Needed:
Phillips Head Screwdriver

Parts Needed:
Keypad Part# **001-2033**

1. Remove the Back Cover of the LCD Monitor (Figure A).
2. Carefully pull the Ribbon Cable out of the connector (Figure B & C).
3. Gently lay the LCD on it's back and peel off the old Keypad (Figure D).
4. Remove the old Keypad from the slot in the plastic (Figure E).

(Continued on next page)



Figure A

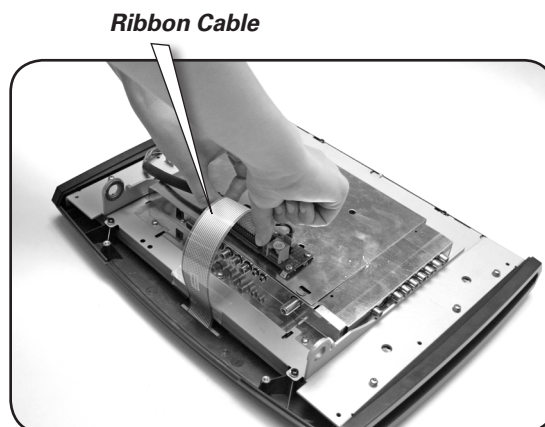

Figure B

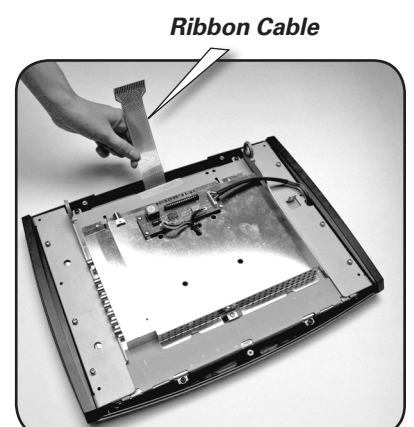

Figure C



Figure D

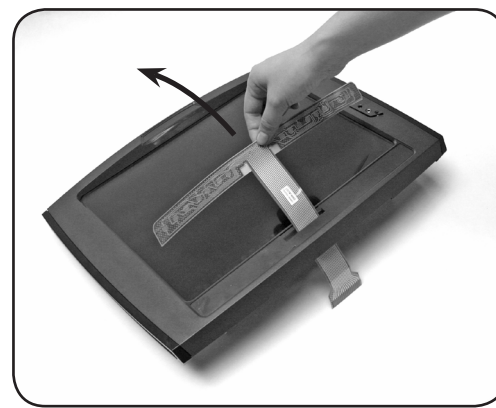

Figure E

Replacing Keypad

Replacing Keypad (Continued)

5. Insert the new Keypad ribbon cable through the slot with the adhesive side toward the bottom of the LCD. (Figure F)
6. Peel off the Adhesive Backing .(Figure G)
7. Position the Keypad on the plastic and firmly press into place. (Figure H & I)
8. Turn the LCD over and insert the Ribbon Cable into the connector. (Figure J)
9. Replace the Back Cover. (Figure K)



Figure F

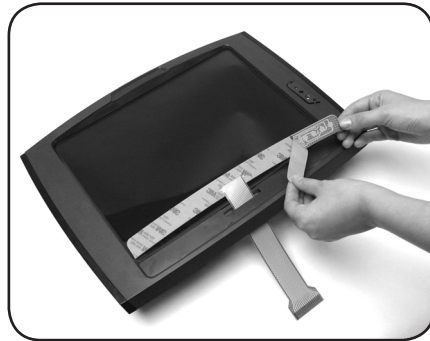

Figure G



Figure H



Figure I

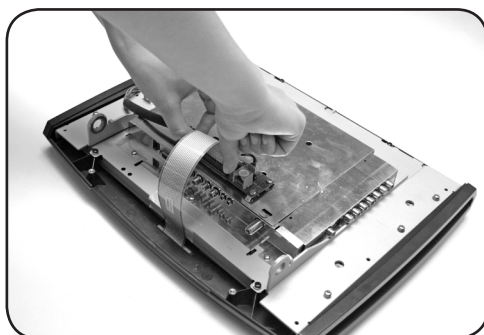

Figure J



Figure K

Troubleshooting

Poor Sound or Display Quality

- Make sure the Antenna is properly connected to the LCD Monitor, lower connection on the unit and the video source.
- Check the Antenna Cable for damage.

No Image

- Make sure the Antenna is properly connected to the LCD Monitor, lower connection on the unit and the Video source.
- Check the Antenna Cable for damage.
- Make sure the Power Cord is properly connected to the unit and a wall outlet.
- Press **POWER** button on remote.

Black Background Only

- Make sure the mode is set to TV and not PC or Video/S-Video when using a coaxial cable input source.

Interference or Shaky Display

- Other appliances such as hair dryers, wireless phones, power tools, etc. can cause interference.
- Execute the fine tuning adjustment.

Can't Store a Specific Channel

- Check whether Channel Setting is set to Normal.

No Sound

- Press the Mute button.
- Press the Volume Up button.
- Replace Headphone Jack

Remote Doesn't Work

- Try the remote on another LCD Display if available.
- Make sure you have fresh batteries.
- Check or replace the Headphone Jack on the front of the LCD Monitor.

If you need further assistance, parts or service please contact Customer Service.

LIMITED WARRANTY

All Nautilus® exercise products are warranted to the retail purchaser to be free from defects in materials and workmanship. Warranty coverage valid to the original purchaser only and proof of the purchase will be required. Any product sold or placed in an application not recommended by Nautilus, Inc. will void any warranty coverage set forth by Nautilus, Inc. warranty policies and procedures.

Time Period:

LCD Monitor: 1 Year

Plastics Stands and Cables: 3 Years

Labor: 1 Year

What this warranty does not cover:

1. Any component on original equipment which carries a separate consumer warranty of the parts supplier.
2. Any damage, failure or loss caused by accident, misuse, neglect, abuse, improper assembly, improper maintenance, failure follow instructions or warnings in Owner's Manual or disaster (such as floods or power surges).
3. Use of product in an application not recommended by Nautilus, Inc. or in a manner or environment for which it was not designed.
4. Damage due to normal wear and tear.

Limitations:

The preceding warranties are the sole and exclusive express warranties made by Nautilus, Inc. They supersede any prior, contrary or additional representations, whether oral or written. No agent, representative, dealer or employee has the authority to alter or increase the obligations or limitations of this warranty. Any implied warranties, including the WARRANTY OF MERCHANTABILITY and any WARRANTY OF FITNESS FOR A PARTICULAR PURPOSE, are limited in duration to the term of the applicable express warranty provided above, whichever is longer. Some states do not allow limitations on how long an implied warranty lasts, so the above limitation may not apply to you.

What Nautilus, Inc. will do:

Nautilus, Inc. liability hereunder is expressly limited to the replacement of goods not complying with this warranty or, at Nautilus, Inc. election, to the return of the purchase price of the exercise product in question. THESE REMEDIES ARE THE EXCLUSIVE AND SOLE REMEDIES FOR ANY BREACH OF WARRANTY. Nautilus, Inc. shall in no event be liable for incidental or consequential losses, damages or expenses in connection with its exercise products. Some states do not allow the exclusion or limitation of incidental or consequential damages, so the above limitation may not apply to you

Procedures:

Warranty service will in most cases be performed by an authorized Nautilus® Fitness Dealer or Service Technician. The original purchaser must provide proof of purchase. Service calls and/or transportation to and from the Nautilus® Dealer is the responsibility of the purchaser.

1. Nautilus, Inc. will have the option to repair or replace any exercise product, which requires service.
2. Nautilus, Inc. is not responsible for dealer labor charges for the component changeovers completed after the labor related warranty period stated herein.
3. If you elect to repair an exercise product or part yourself, using the services of someone other than an authorized Nautilus® Fitness Dealer or Service Technician, or use a replacement part not supplied by Nautilus, Inc., Nautilus Inc. shall not be liable for any cost, damage, failure or loss caused by the use of such unauthorized service or parts.

Important Contact Numbers

If you need assistance, please have both the serial number of your machine and the date of purchase available when you contact the appropriate Nautilus office listed below.

OFFICES IN THE UNITED STATES:

OFFICES IN THE UNITED STATES:

E-mail: customerservice@nautilus.com

- **TECHNICAL/CUSTOMER SERVICE**
Nautilus, Inc.
World Headquarters
16400 SE Nautilus Drive
Vancouver, Washington, USA 98683
Phone: 800-NAUTILUS (800-628-8458)
Fax: 877-686-6466
- **CORPORATE HEADQUARTERS**
Nautilus, Inc.
World Headquarters
16400 SE Nautilus Drive
Vancouver, Washington, USA 98683
Phone: 800-NAUTILUS (800-628-8458)

INTERNATIONAL OFFICES:

For technical assistance and a list of distributors in your area, please call or fax one of the following numbers.

- **INTERNATIONAL OFFICE**
Nautilus International S.A.
Rue Jean Prouvé 6
1762 Givisiez / Switzerland
Tel: + 41-26-460-77-77
Fax: + 41-26-460-77-70
Email: technics@nautilus.com

INTERNATIONAL OFFICES:

- **SWITZERLAND OFFICE**
Nautilus Switzerland S.A.
Tel: + 41-26-460-77-66
Fax: + 41-26-460-77-60
- **GERMANY and AUSTRIA OFFICE**
Nautilus GmbH
Tel: +49-2204-610-27
Fax: +49-2204-628-90
- **ITALY OFFICE**
Nautilus Italy s.r.l.
Tel: +39-051-664-6201
Fax: +39-051-664-7461
- **UNITED KINGDOM OFFICE**
Nautilus UK Ltd.
Tel: +44-1908-267-345
Fax: +44-1908-267-346
- **CHINA OFFICE**
Nautilus Representative Office
Tel: +86-21-523-707-00
Fax: +86-21-523-707-09



Be Strong.™

For more information about our LCD TV Monitor® or other Nautilus® equipment, visit www.nautilusinc.com.

© 2007 Nautilus, Inc. All rights reserved. Nautilus, the Nautilus logo, Be Strong are either registered trademarks or trademarks of Nautilus, Inc. All other marks are either registered trademarks or trademarks of their respective companies.

Nautilus, Inc. World Headquarters, 16400 SE Nautilus Drive, Vancouver, Washington, USA 98683, 1-800-628-8458, www.Nautilus.com.

Printed in China