

C966 Treadmill

Warning: This service manual is for use by Precor trained service providers only. If you are not a Precor Trained Servicer, you must not attempt to service any Precor Product; Call your dealer for service.

This document contains information required to perform the majority of troubleshooting, and replacement procedures required to repair and maintain this product.

This document contains general product information, software diagnostic procedures (when available), preventative maintenance procedures, inspection and adjustment procedures, troubleshooting procedures, replacement procedures and electrical block and wiring diagrams.

To move directly to a procedure, click the appropriate procedure in the bookmark section to the left of this page. You may “drag” the separator bar between this page and the bookmark section to change the size of the page being viewed.

Section One — Things you Should Know

About This Appendix

Section One, Things You Should Know. This section includes technical specifications. Read this section, as well as the C966 Treadmill Owner's Manual, before you perform the maintenance procedures in this manual.

Section Two, Software Features. Precor's C966 Treadmills are programmed with several diagnostic and setup features. This section contains the procedures you need to access the diagnostic features on this treadmill.

Section Three, Checking Treadmill Operation. This section provides you with a quick way of checking treadmill operation. Check treadmill operation at the end of a maintenance procedure and when it is necessary to ensure that the treadmill is operating properly.

Section Four, Inspection and Adjustment Procedures. Perform inspection procedures when a trouble symptom points to a particular problem and after removing and replacing major components. Many maintenance problems can be fixed by adjusting various treadmill components. This section also provides you with the step-by-step procedures required to make these adjustments.

Section Five, Troubleshooting Procedures. The diagnostic and troubleshooting procedures contained in this section should be performed when it is necessary to isolate a problem to a particular component.

Section Six, Replacement Procedures. When a treadmill component must be replaced, go to this section and follow the step-by-step procedures required to remove and replace the component.

Section Seven, Technical Diagrams and Parts Lists. This section includes wiring diagrams, and block diagrams for the C966 Treadmills.

General Information

For the latest exploded view diagram, part number and part pricing information, visit the Precor dealer website at ["www.precor.com/Dealer"](http://www.precor.com/Dealer).

Technical Specifications

Physical Specifications

Length:	84 inches (213 cm.)
Width:	Handrails 36.75 inches (93 cm.) Base 33.75 inches (86 cm.)
Height:	57 inches (145 cm.)
Running surface:	26 inches by 60 inches (51 cm. by 152 cm.)
Motor:	4 hp. continuous duty DC
Speed:	0.5 to 16 m.p.h. (0.8 to 25.6 k.p.h.) 10 m.p.h. is equivalent to a 6 minute mile
Incline:	0% to +12% grade
Power:	120 Vac 50/60 Hz @ 20 amp 240 Vac 50/60 Hz @ 20 amp
Weight:	350 lbs (158 kg.)
Shipping Weight:	460 lbs (207 kg.)

Procedure 2.1 — Accessing the Diagnostic Software

The treadmill's diagnostic software consists of the following modes:

- Display Test
- Keyboard Test
- Heart Rate Test
- Lift Test
- Belt Speed Test
- Belt Power Test
- Circuit Breaker Test

Procedure

1. Plug the power cord into the wall outlet, then turn on the treadmill with the circuit breaker.
2. The keys on the display are hypothetically numbered 1 to 7 from left to right. See Diagram 2.1. The **STOP** is key number 4 and is located directly below the **QUICK START** key.
3. With the **PRECOR** banner scrolling, press keys **RESET,5,1,7,6,5,7,6,1**, sequentially. The display test will be initiated.
4. Watch the electronic display as the display test progresses. This test illuminates all of the LED's on the display. If all of the LED's do not illuminate, replace the upper PCA per Procedure 5.2 of the Commercial Treadmill Service Manual.
5. Press the **STOP** or **ENTER** key to proceed to the keyboard test.

Diagram 2.1 — C966 Treadmill Display



6. The keyboard test will place two dots on the display for each key on the display, including the numeric keypad. Pressing a key will cause the upper of the two dots associated with the key to go out. Test all of the keys in this manner. Tug on the safety key lanyard, to ensure that the **STOP** key is operating normally.
7. Press and hold the **STOP** key or **ENTER** key to proceed to the heart rate test.
8. The heart rate test will display the heart rate being received during this test from either a chest strap transmitter, the hand held system or a test transmitter.
9. Three heart rate values will be displayed. They are prefixed “U” for unfiltered, “F” for filtered and “P” for Polar filtering. The Polar filtered heart rate will also appear in the normal heart rate display, since Polar filtering is the filtering used during normal operation. The right most red LED in the smart rate display will flash each time a heart beat is detected.
10. Press the **STOP** or **ENTER** key to proceed to the lift test.
11. Two numbers will be displayed, the percent of lift and A/D number related to the current lift position. The A/D (analog to digital) number represents the lift potentiometer reading. The A/D number will be in the range of 0 to 255.
12. The lift may be operated using the **INCLINE** keys. The incline percentage and A/D numbers will change accordingly. Care must be taken while operating the lift in this mode because the normal upper and lower range limits are not in effect. It is possible to operate the lift to it's physical limits and may cause the lift motor to jam.
13. The A/D reading will be used later in this service manual to calibrate the lift.
14. Press and hold the **STOP** or press the **ENTER** key to proceed to the belt speed test.
15. The speed of the running belt is controlled by the **SPEED** keys during this test.
16. The following values are displayed; time (that the running belt has operated during this test), current (in amps through the drive motor), belt speed (in MPH) and power bits (PWM value).
17. This test is valuable in diagnosing treadmill load conditions such as running bed and/or running belt condition. As load is increased, the speed is kept at a constant value (as set via the **SPEED** keys) and the current and power bits will vary proportionately to the load.
18. It is suggested that you perform this test on a treadmill known to be in excellent operating condition. Note the values displayed at a fixed speed (such as 3 MPH) and your body weight. Those values may then be used to benchmark the operation of treadmills you are diagnosing.
19. Press and hold the **STOP** or press the **ENTER** key to proceed to the belt power test.
20. The belt power test is similar to the belt speed test except that the **SPEED** keys control the power bits (PWM value) instead of the belt speed.
21. The same (see step 16) values will be displayed as in the belt speed test.

22. This test is valuable in diagnosing treadmill response to load conditions. As load is increased, the power bits are kept at a constant value (as set via the **SPEED** keys) and the current and belt speed will vary proportionately to the load.
23. It is suggested that you perform this test on a treadmill known to be in excellent operating condition. Note the values displayed at a fixed power bit reading (as set by the **SPEED** keys) and your body weight. Those values may then be used to benchmark the operation of treadmills you are diagnosing.
24. Press the **STOP** or the **ENTER** key to proceed to the circuit breaker test.
25. The message **HOLD ARROW KEY TO TRIP** will be displayed. When the arrow key is held, the message **BREAKER WILL TRIP 3 2 1** will flash on the screen one word at a time. Shortly after the **1** is displayed, the circuit breaker will trip. If the arrow key is released before the circuit breaker trips, the test will be terminated.
26. The circuit breaker test is the last test in the diagnostics routine. If you do not wish to cause the circuit breaker to trip, press the **RESET**, **STOP** or the **ENTER** key to exit the diagnostics routine.

Procedure 2.2 — Displaying Information

The information display will access the following data;

- Odometer
- Hour meter
- Software version
- Error log
- Serial Number

Procedure

1. Plug the power cord into the wall outlet, then turn on the treadmill with the circuit breaker.
2. With the **PRECOR** banner scrolling, press the keys **RESET,6,5**, sequentially. The odometer display will be initiated.
3. The treadmill's odometer will be displayed as **1234567 MPH** or **1234567 KPH** depending on club settings (See Procedure 2.3).

Note: The odometer data is stored in non-volatile memory on the upper PCA. If the upper PCA is replaced the odometer data will be lost.

4. Press the **STOP** or the **ENTER** key to proceed to the hour meter display.'
5. The operating time of the unit will be displayed as **12345 HOURS**. The operating time is defined as total amount of time that the unit has operated in program modes with the drive motor running. The hour meter is also used to provide the "time stamp" for the error code log.
6. Press the **STOP** or the **ENTER** key to proceed to the software version display.
7. The software versions of the upper and lower PCA's will be displayed as;
UPPER X.XX LOWER X.XX
8. Press the **STOP** or the **ENTER** key to proceed to the error log.
9. The error log will store up to 10 error conditions. The errors are logged with the most recent error in position one. When a new error condition occurs, each existing error is pushed down one position in log. If there was an error in position 10 when a new error was logged, the error that was in position 10 will be lost.
10. Each error in the log will show the odometer reading (in miles) and the time (hour meter) when the error occurred. The errors are displayed as;
1 ER20 1234567 MI 12345 HRS.

11. The arrows keys will allow you to scroll through the log. When the first unused position is reached in the log, the message **NO MORE ERRORS** will be displayed.
12. If you wish to clear the error log of all existing errors, follow the procedure in step 13.
13. When the **QUICK START** key is held for 2 seconds the message **HOLD TO CLEAR ERRORS** will be displayed. If the **QUICK START** key is held for an additional 2 seconds, the message **CLEARED** will be displayed. When the **QUICK START** key is released the message **NO MORE ERRORS** will be displayed and all error are erased from the log.
14. Press the **STOP** or the **ENTER** key to proceed to the serial number display.
15. The unit's serial number will be displayed.
16. Press the **RESET**, **STOP** or the **ENTER** key to exit the information display.

Procedure 2.3 — Selecting Club Settings

This procedure allows you to change the following club settings:

- Language
- Measurement Units
- Maximum Speed
- Maximum Workout Time
- Maximum Pause Time
- Cool Down Time
- Fitness Test Enable/Disable
- Modify Custom Courses

Procedure

1. Plug the power cord into the wall outlet, then turn on the treadmill with the circuit breaker.
2. With the banner scrolling, press keys **RESET,5,6,5,1,5,6,5**, sequentially. The select language display will be initiated.

Selecting Language

3. The prompt **SELECT LANGUAGE** will be displayed. The currently selected language will then be displayed.
4. Use the **▲,▼** keys to scroll through the available languages.
5. Press the **ENTER** key to select the currently displayed language or the **STOP** key to leave the original language selected.

Select Measurement Units

6. The prompt **SELECT UNITS** will be displayed. The currently selected measurement unit will then be displayed.
7. Use the **▲,▼** keys to toggle between **U.S. STANDARD** and **METRIC** measurements..
8. Press the **ENTER** key to select the currently displayed measurement unit or the **STOP** key to leave the original measurement unit selected.

Select Maximum Speed

9. The prompt **SET MAX SPEED** will be displayed. The currently selected maximum speed will then be displayed in either MPH or KPH depending upon the measurement units selected.

10. Use the ▲,▼ keys to scroll through the possible range of maximum speeds.
11. Press the **ENTER** key to select the currently displayed maximum speed or the **STOP** key to leave the original maximum speed selected.

Select Maximum Workout Time

12. The prompt **SET MAX WORKOUT TIME** will be displayed. The currently selected maximum workout time will then be displayed.
13. Use the ▲,▼ keys to scroll through the possible range of maximum workout times. It is possible to select **NO LIMIT** as the maximum workout time. When **NO LIMIT** is selected, the user is allowed an infinite workout time.
14. Press the **ENTER** key to select the currently displayed maximum workout time or the **STOP** key to leave the original maximum workout time selected.

Select Maximum Pause Time

15. The prompt **SET MAX PAUSE TIME** will be displayed. The currently selected pause time will then be displayed.
16. Use the ▲,▼ keys to scroll through the possible range of pause times. The maximum pause time is the amount of time the treadmill remains in pause mode before the course is terminated and the banner is displayed.
17. Press the **ENTER** key to select the currently displayed pause time or the **STOP** key to leave the original pause time selected.

Select Cool Down Time

18. The prompt **SET COOL Down** will be displayed. The currently selected cool down time will then be displayed.
19. Use the ▲,▼ keys to scroll through the possible range of pause times. The cool down time is the amount of time the treadmill remains in the cool down mode before the course is completed.
20. Press the **ENTER** key to select the currently displayed cool down time or the **STOP** key to leave the original cool down time selected.

Fitness Test Enable/Disable

21. Club personnel may choose to either have or not have a Fitness Test available for the user.
22. Use the ▲,▼ keys to toggle between **FITNESS TEST ENABLED** and **FITNESS TEST DISABLED..**

23. Press the **ENTER** key to select the currently display or the **STOP** key to leave the original display.

Modify Custom Courses

24. The prompt **MODIFY CUSTOM COURSE 1** will be displayed. The currently stored custom course will then be displayed. The left most column of the course blinks, indicating that it is the column selected for modification.
25. The **SPEED ▲ & SPEED ▼** keys to change the column selected for modification. The **INCLINE ▲ & INCLINE ▼** keys to change the incline of the selected column.
26. Press the **ENTER** key to save the modified custom course or the **STOP** key to leave the custom course unchanged.
27. The prompt **MODIFY CUSTOM COURSE 2** will be displayed. The currently stored custom course will then be displayed.
28. Custom course 2 may be modified in the same manner as above, see steps 18 through 20.
29. After the custom course 2 has been viewed or modified, pressing the **ENTER, STOP** or **RESET** key will exit the club settings routine

Procedure 2.4 — Documenting Software Problems

When a problem is found with the software in the upper or lower PCA, record the information listed below.

When a problem occurs, record the following information:

- Model and serial number
- Software version number

- Program number running when the problem occurred
- A description of:
 - - a. What happened or failed to happen.
 - b. The action taken by the user just before the problem occurred.
 - c. Problem-related information (such as how far into the program the problem occurred, the work level being used when the problem occurred, etc.).

- The frequency of occurrence.

Section Three — Checking Treadmill Operation

This section provides you with a quick method of checking treadmill operation. Check treadmill operation at the end of a maintenance procedure and when it is necessary to ensure that the treadmill is operating properly.

Procedure

4. Plug the power cord into the wall outlet, then turn on the treadmill with the circuit breaker.
5. Place the treadmill in Manual Mode. Adjust the speed of the running belt to 2–3 m.p.h. Operate the treadmill for at least 5 minutes.
 - a. Concentrate on the feel of the running belt and the sound of the drive motor and rollers. Be on the alert for unusual noises, smells, or vibrations.
 - b. Log the power bits under loaded and unloaded conditions.
 - c. Observe the LED's on the electronic console. Make sure that each LED lights as the information corresponding to that LED is displayed on the electronic console.
3. If during step 2B, squeaking noises associated with the running deck were heard, check the lubrication of the running deck studs. If necessary, apply silicon grease to all of the running deck studs.
3. Press the **STOP** key. When the treadmill comes to a stop, view the electronic console as the treadmill scans time, speed, distance and percent of lift.
4. Press the **INCLINE ▲** key while viewing the electronic console. Confirm that the running bed inclines and the incline display increments to 12% as the **INCLINE ▲** key is pressed.
5. Press the **INCLINE ▼** key while viewing the electronic console. Confirm that the running bed returns to a level position and the incline display decrements to -3% as the **INCLINE ▼** key is pressed.
6. Turn off the treadmill with the circuit breaker, then unplug the treadmill from the wall outlet.

Procedure 4.1 — Calibrating the Lift Motor

1. Set the treadmill circuit breaker in the “off” position and unplug the line cord from the wall outlet.
2. Remove the hood.
3. Place the treadmill on it's right side. Remove hitch and clevis pins that secure the lift tube to the lift platform. See Diagram 4.1.

Diagram 4.1 — Lift Motor Mounting

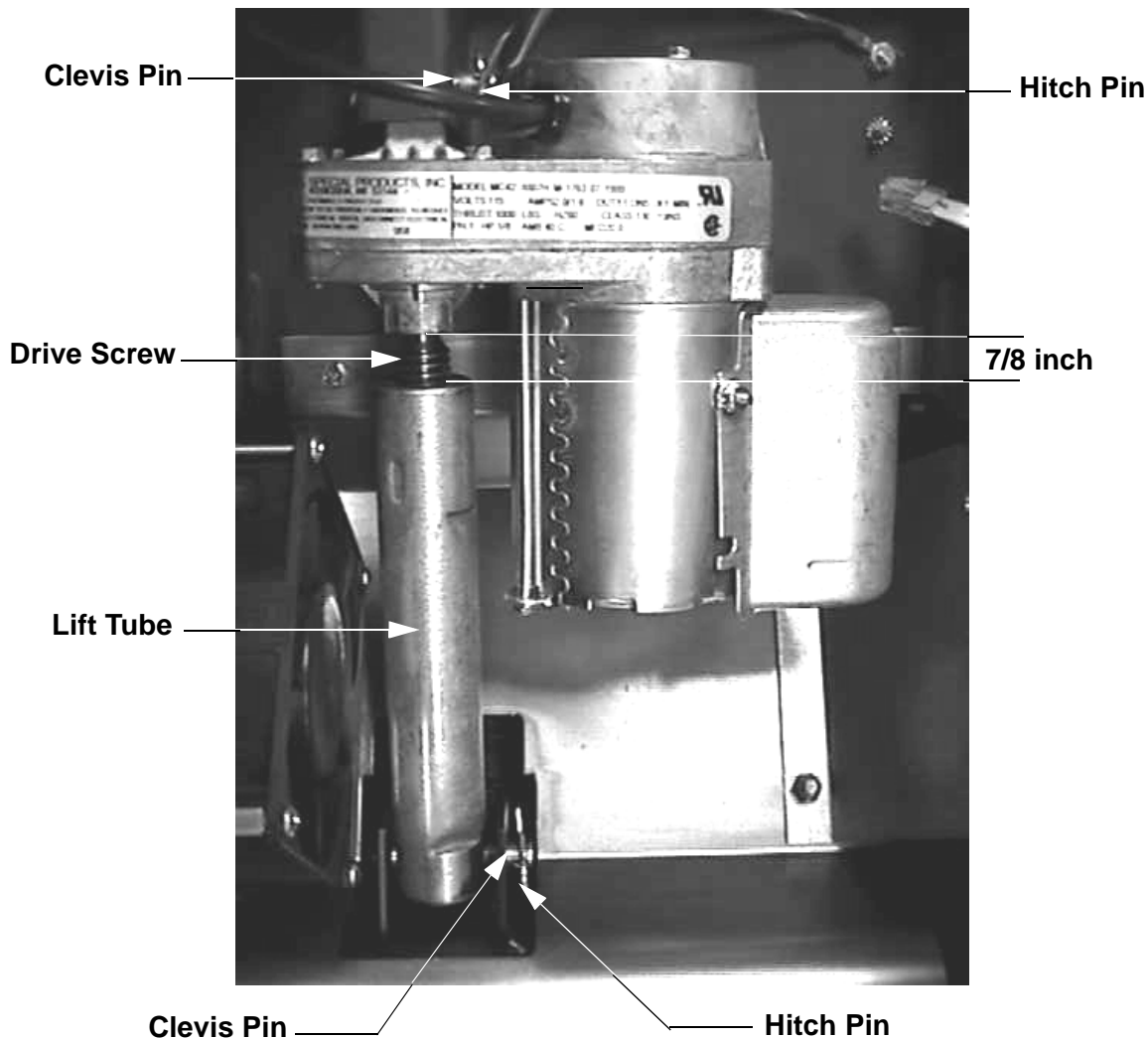

4. Plug the power cord into the wall outlet, set the treadmill circuit breaker in the “on” position.
5. Press keys **RESET, 5,1,7,6,5,7,6,1**, sequentially to enter the diagnostics routine. Refer to Procedure 2.1 and advance to the lift test. When the lift calibration number is displayed on the console, use the **INCLINE ▲** or **INCLINE ▼** key to set the lift calibration number to 20.

CAUTION

While running the lift motor in the diagnostics mode it is possible to operate the lift motor beyond its normal range of motion. When you perform the next step, care must be taken not to jam the lift tube against the motor frame.

6. Press the **RESET** key to exit the diagnostics mode.
7. Set the treadmill circuit breaker in the “off” position, unplug the line cord from the wall outlet.
8. Rotate the lift tube clockwise, by hand, as far as possible. Then rotate the lift tube counter-clockwise until the distance from the top of the lift tube to the lift motor is 7/8 inch. See Diagram 4.1. While rotating the lift tube, be sure the lift motor drive screw does not rotate. If the drive screw is rotated, return to step 4 and repeat steps 4 through 7.
9. Replace the clevis and hitch pins removed in step 3. Return the treadmill to an upright position.
10. Plug the line cord into the wall outlet, set the treadmill circuit breaker in the “on” position.
11. Check the calibration of the lift system by performing the following steps:
 - a Press the **INCLINE ▲** key until the console displays 12% incline.
 - b Press the **INCLINE ▼** key to return to -3% incline.
12. Re-install the hood.

Procedure 4.2 — Adjusting Drive Belt Tension

1. Set the treadmill circuit breaker in the “off” position and unplug the line cord from the wall outlet.
2. Remove the hood.
3. Place the drive belt tension gauge on the drive belt as shown in Diagram 4.2.

Diagram 4.2 — Drive Belt Tension Gauge



4. The gauge should read approximately 80 inch/pounds. The drive belt tension is acceptable if it is in the range of 70 to 90 inch-pounds.
5. If the drive belt tension is less than 70 or greater than 90 inch/pounds, slightly loosen the four drive motor mounting bolts. The drive motor mounts on slotted holes allowing the drive motor to be move forward or rearward. Move the drive motor forward or rearwards, as required, until the belt gauge reads approximately 80 inch/pounds and tighten the four drive motor mounting bolts. See Diagram 4.3. Momentarily remove the drive belt tension gauge from the drive belt. Replace the drive belt tension gauge on the drive belt and re-adjust the drive belt tension, if necessary. Torque the four drive motor mounting bolts to 180 inch pounds.

Diagram 4.3 - Drive Belt Adjustment

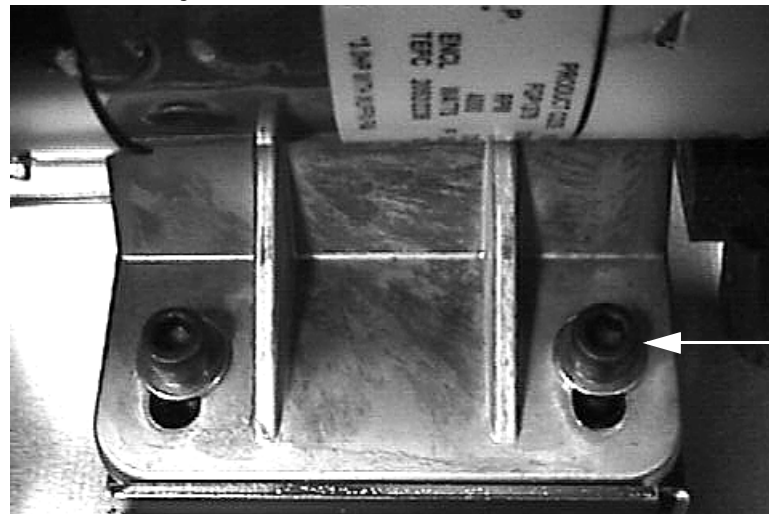

Drive Motor
Mounting Bolt

6. Re-install the hood.
7. Plug the line cord into the wall outlet and set the treadmill circuit breaker in the “on” position.
8. Check treadmill operation per Section 3.

Procedure 4.3 - Treadmill Belt Cleaning

Procedure:

1. First, check for proper operation of the safety stop key. Stand to one side of the treadmill. Insure that the stop key tether is hanging straight down from the stop key and is not wrapped around the handle bars. Push the "Quick Start" button and wait for the display to count down and for the running belt to begin moving. Once the running belt is moving pull the safety stop key tether. **See the illustration below.**

CAUTION: If the running belt does not stop, turn off the power using the ON/OFF switch at the front of the treadmill and unplug the power cord. The treadmill must remain out of service until the stop switch is repaired.
If the running belt stops, continue with the cleaning procedure.

2. A clean, dry towel approximately 36 inches or 1 meter in length is required. Fold the towel in half lengthwise, lift the running belt up and insert the towel beneath the belt so that an end of towel extends on to each deck trim. **See the illustration below.**



3. Stand to one side of the treadmill, push the "Quick Start" button, grasp the towel as illustrated in the illustration above. **Note:** You will have 3 seconds to firmly grasp your hands on the towel before the treadmill running belt begins to move. Allow the treadmill to run for about one minute while holding the towel firmly in place.

CAUTION: If the towel becomes loose it may be pulled into the treadmill's rollers. Pull the safety key tether to stop the treadmill and retrieve the towel, no damage should occur. Start the procedure over again.
See the illustration below.

4. Keep one hand firmly grasped on the towel, use your other hand to pull on the safety stop key tether to stop the treadmill running belt. **See the illustration below.**

5. Turn the power off. Place your hands on the towel and push it up and down the length of the running deck several times to clean the deck.
6. Remove the towel.

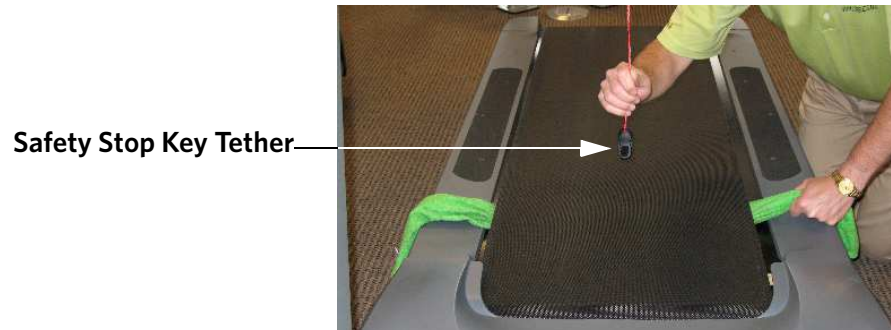

It is recommended that this procedure be performed frequently to extend the life of the running belt and running deck.

Procedure 5.1 — Troubleshooting the Keypad and Upper PCA

If the function keys on the electronic console are unresponsive, the problem may be either the upper PCA or keypad. The keys on this unit are touch sensitive keys. It is necessary to use the keypad diagnostics to troubleshoot the key functions.

Procedure

1. Set the circuit breaker in the “off” position.

WARNING

Before continuing with this procedure, review the Warning and Caution statements listed in Section One of the Commercial Treadmill Service Manual.

2. If the treadmill powers up and functions normally until a particular key(s) is pressed, skip to step 11.
3. If a “key depressed” message is immediately displayed when the treadmill is powered up, continue with the next step.
4. This condition may be caused by either the keypad or upper PCA. Set the circuit breaker in the “off” position.
5. Remove the four screws that fastens the display housing front panel to the display housing backing plate. These screws are located on the rear of the display housing backing plate.
6. Lift the display housing front panel off of the display housing backing plate. Remove the keypad connector from the upper PCA. See Diagram 5.1.

Diagram 5.1 — Upper PCA & Keypad

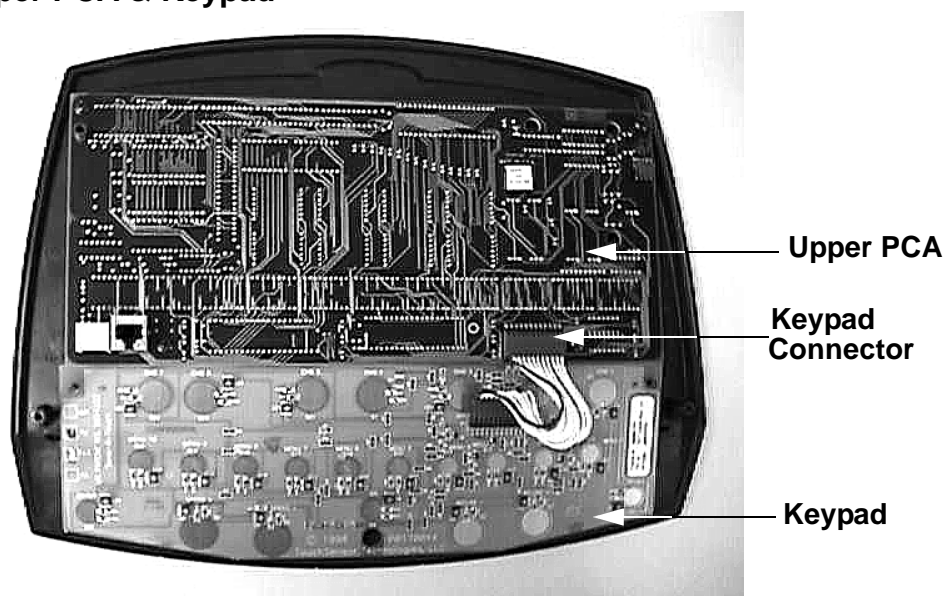

7. Set the circuit breaker in the “on” position.
8. If a “key depressed” message is immediately displayed when the treadmill is powered up, replace the upper PCA.
9. If a “key depressed” message is not displayed when the treadmill is powered up, replace the display housing front panel. The display housing front panel is equipped with the keypad.
10. If you have performed all of the procedures above and have been unable to correct the problem, call Precor customer service.
11. Access the diagnostics program per procedure 2.1. If the key(s) necessary to access the diagnostic program is not functioning, skip to step 14.
12. Test the keypad per Procedure 2.1, step 6.
13. If all of the keys test good, the problem may be user error or a key function that is normally disabled during a particular user program.
14. If one or more keys do not function correctly, either the keypad (display housing) or upper PCA could be defective. Replace the display and repeat step 12. If the display housing did not correct the problem, re-install the original display housing and replace the upper PCA.
15. If you have performed all of the procedures above and have been unable to correct the problem, call Precor customer service.

Procedure 5.2 — Troubleshooting the Speed Sensor

Note:

The speed sensor is a hall effect sensor that emits a pulse when a flywheel lobe passes between its transmitter and receiver. The speed control circuit processes the pulse train emitted by the speed sensor. The speed sensor signal is a real time representation of the operating speed of the treadmill. The speed control circuit compares the real time speed (speed sensor output) with the speed that it expects the treadmill to be operating at and acts accordingly to control treadmill speed or initiate an error code sequence, if necessary. Typically, if a problem exists with the speed sensor the drive motor will operate (perhaps only briefly) before a speed related error occurs (errors 20-26).

1. Set the treadmill circuit breaker in the “on” position. Using a DC voltmeter, measure the voltage between terminal 3 of J2 (green wire) and terminal 4 of J2 (black wire) on the lower logic PCA. Slowly, rotate the drive motor flywheel. The voltage should read approximately 5 Vdc when a flywheel lobe is between the speed sensor “legs” and approximately 0.25 Vdc when a flywheel lobe is not between the speed sensor “legs”.

Diagram 5.3 — Speed Sensor Mounting

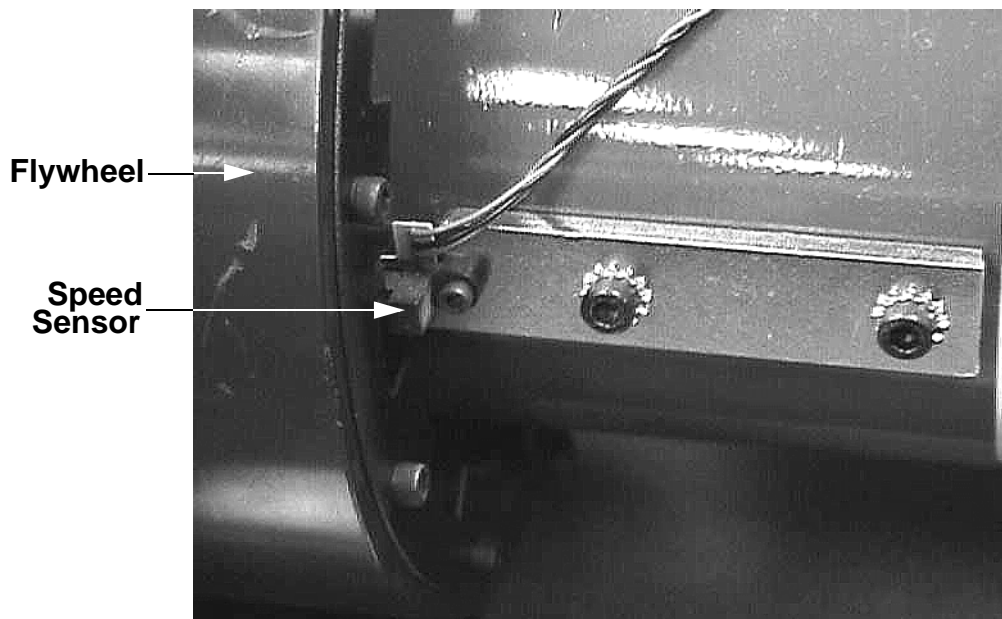

2. If the voltages in step 1 are correct, go to step 5. If the voltage in step 1 is 0 Vdc or significantly low when a flywheel lobe is between the speed sensor “legs”, continue with step 3.
3. Measure the voltage between terminal 1 of J2 (red wire) and terminal 4 of J2 (black wire) on the lower PCA. The voltage should read approximately 5 Vdc.

4. If the voltage is missing or significantly low, disconnect the speed sensor plug from the lower PCA. Measure the voltage between pins 1 & 4 of the J2 plug on the lower PCA. If the voltage is approximately 5 Vdc, replace the speed sensor. If the voltage is missing or significantly low, replace the lower logic PCA.
5. At this point the speed sensor output is good, but a speed error occurs. There are two potential causes for this condition. They are upper PCA or lower logic PCA. There are no good means of troubleshooting these components other than substituting known good components. Replace only one component at a time. If the component that you replaced does not correct the problem, replace the original component. Try substituting the lower logic PCA first then the upper PCA, if necessary.
6. If you have performed all of the above procedures and have been unable to correct the problem, call Precor Customer Support.

Procedure 5.3 — Troubleshooting Hand Held Heart Rate

Circuit Description

The hand held heart rate system is actually a dual system, that is, it can accept a heart rate signal from either the hand held heart rate contacts on the unit's handlebar or from a Polar heart rate chest strap transmitter. The PCA is configured for hand held priority. That is, if both a chest strap and hand heart rate signal are being received, the system will accept the hand held signal and ignore the chest strap signal. If a hand held signal is not being received, the system will accept the chest strap signal.

Note:

There are four typical failure modes for the hand held/chest strap heart rate system. They are: hand held is normal - no chest strap reading; no hand held reading - chest strap normal; no hand held or chest strap reading or constant or intermittent readings when neither hand held or chest strap are in use.

Diagram 6.3 - Hand held/chest strap heart rate PCA

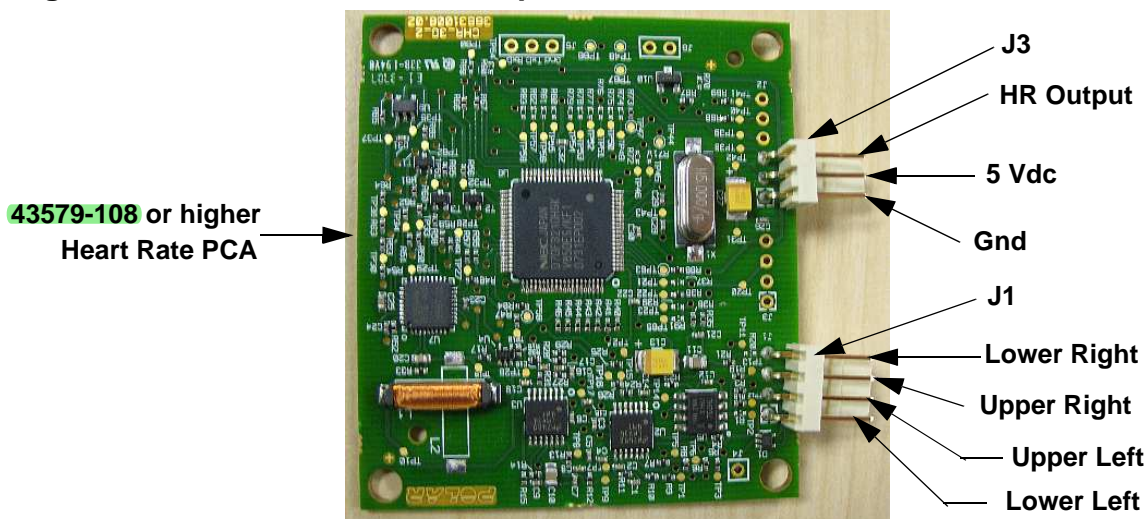

Normal hand held reading - No chest strap reading

1. Access the diagnostic program (Procedure 3.2). Advance to the heart rate display portion of the diagnostic program. Verify that a chest strap signal is not being accepted with either a Polar heart rate test transmitter or a known good chest strap transmitter. If this reading is good, skip to step 3.
2. Using a known good Polar heart rate chest strap, verify that the heart rate operates with the known good chest strap. If the known good Polar chest strap does corrects the problem, replace the original chest strap transmitter.
3. If the above procedures did not correct the problem, replace the heart rate PCA.

No hand held reading - Normal chest strap reading

4. Access the diagnostic program (Procedure 3.2). Advance to the heart rate display portion of the diagnostic program. Verify that a hand held signal is not being accepted by firmly grasping both the right and left hand held contacts on the handlebars. Cover as much of the contact surface area with your hands as possible (without moving your hands), you should receive a heart rate reading within ten seconds.
5. If the hand held signal is now being accepted, something in the near vicinity is radiating RF (radio frequency) energy that is being received by the chest strap portion of the heart rate PCA.
6. If a hand held signal still not being accepted, skip to step 8.
7. Replace the heart rate PCA with a **43579-108** (or higher) heart rate PCA. **43579-108** and higher versions of heart rate PCA are less susceptible to radiated RF energy.
8. Access the diagnostic program (Procedure 3.2). Advance to the heart rate display portion of the diagnostic program. Verify that a hand held signal is not being accepted by firmly grasping both the right and left hand held contacts with the opposite hands, right hand on the left handlebar contacts and left hand on the right handlebar contacts. Cover as much of the contact surface area with your hands as possible, you should receive a heart rate reading within ten seconds. If a hand held signal is still not being accepted, skip to step 10.
9. If a hand held signal was accepted in step 11, the hand held contact wiring is reversed. The end of the wire harness that connects to the hand held contacts in the handlebar is segregated into two groups. One group has blue shrink wrap around it and the other group has black shrink wrap around it. The "blue" group must go to the right hand contacts and the "black" group must go to the left hand contacts. In both groups the black wire must go to the lower contact and the red wire must go to the upper contact. If necessary, rewire the hand held contacts as described above and test as described in step 4.
10. If the wiring is correct, refer to Diagram 6.3 for the following measurements. With an ohmmeter measure between the "lower right contact" pin on the J1 connector and the lower right hand held heart rate contact on the handlebar. The reading should be 1 Ω or less. Measure between the "upper right contact" pin on the J1 connector and the upper right hand held heart rate contact on the handlebar. The reading should be 1 Ω or less. Measure between the "upper left contact" pin on the J1 connector and the upper left hand held heart rate contact on the handlebar. The reading should be 1 Ω or less. Measure between the "lower left contact" pin on the J1 connector and the lower left hand held heart rate contact on the handlebar. The reading should be 1 Ω or less. If any of the above readings are greater than 1 Ω , replace the heart rate PCA to handlebar wire harness.

No hand held reading - No chest strap reading

11. Access the diagnostic program (Procedure 3.2). Advance to the heart rate display portion of the diagnostic program. Verify that neither a chest strap signal or a hand held signal is being accepted with either a heart rate test transmitter or a chest strap transmitter.
12. Check the plug/connector connections on both the heart rate PCA (J4), and upper PCA (J1).
13. If neither a chest strap signal or a hand held signal is being accepted, measure between the "ground" and "5 Vdc" pins on J4 for 5 Vdc. If 5 Vdc is present, replace the heart rate PCA.
14. If 5 Vdc is not present, remove the connector from J4 of the heart rate PCA. Measure between the "ground" and "5 Vdc" pins of the connector (just removed from the heart rate PCA) for 5 Vdc. If 5 Vdc is present, replace the heart rate PCA. If the 5 Vdc is not present, measure between the corresponding pins of J1 on the upper PCA (red and black wires). If 5 Vdc is not present replace the upper PCA. If 5 Vdc is present, replace the upper PCA to heart rate PCA cable.

Constant or intermittent readings when neither the hand held or chest strap is in use

15. Verify that a ferrite core is clamped around the heart rate PCA to upper PCA cable.
16. Constant or intermittent heart rate readings when neither heart rate system is in use is caused by something in the near vicinity radiating RF energy that is being received by the chest strap portion of the heart rate PCA.
17. Replace the heart rate PCA with a **43579-108** (or higher) heart rate PCA. **43579-108** and higher versions of heart rate PCA are less susceptible to radiated RF energy

Procedure 5.4 — Troubleshooting the External A.C. Power Source

It is extremely important that any Precor treadmill be connected to and operated on a dedicated 20 amp A.C. circuit. A 20 amp dedicated circuit is defined as: a circuit fed by a 20 amp circuit breaker that feeds a single load. A treadmill operating from a non-dedicated circuit or a circuit breaker of less than 20 amps capacity will not have the necessary power available to operate normally under higher load conditions. The lack of available power can cause any number of symptoms ranging from numerous intermittent (seemingly inexplicable) error conditions, poor speed control, or tripping the house circuit breaker.

If any of the above symptoms exist the external A.C. circuit must be checked and confirmed to be a 20 amp dedicated circuit **before** troubleshooting the treadmill.

In addition the A.C. voltage must be checked. Nominal A.C. operating voltage on 120 Vac circuits is 105 Vac to 120 Vac. Nominal A.C. operating voltage on 240 Vac circuits is 208 Vac to 240 Vac. For operator safety considerations and to minimize electrostatic discharge conditions the A.C. frame ground continuity must also be verified to be a low resistance connection to the A.C. distribution ground bar.

Important

If the A.C. circuit feeding a treadmill is found to be a non-dedicated circuit or a circuit equipped with a circuit breaker with a capacity of less than 20 amps, the A.C. circuit must be corrected to be a 20 amp dedicated circuit **before** any reliable troubleshooting can be performed on the treadmill. More importantly, a non-dedicated circuit may constitute a safety hazard to the treadmill operator.

120 Vac Systems

120 Vac distribution systems utilize a single pole circuit breaker (hot lead) and a neutral lead connected to a common neutral (ground) bar. The A.C. safety ground (green wire) is connected to a separate ground bar in the distribution system.

The most common problems found are (1) the circuit is fed by a circuit breaker of less than 20 amp capacity, (2) the circuit breaker correctly feeds a single A.C. outlet but the neutral is common between several A.C. outlets and (3) both the hot and neutral leads feed several A.C. outlets. The appropriate correction action or actions (see below) must be followed if any of the above conditions exist. **Corrective actions should only be undertaken by a licensed electrician.**

1. The circuit breaker feeding the treadmill is not a 20 amp circuit breaker.

If the circuit breaker is greater than 20 amps, the circuit breaker should be replaced with a 20 amp circuit breaker. If the circuit breaker is less than 20 amps the circuit breaker must be replaced with a 20 amp circuit breaker and the wiring from the A.C. distribution must be capable of safely handling 20 amps. If the A.C. wiring is under sized, it must be replaced with wire capable of safely handling 20 amps. Please, refer to local electrical codes when determining the appropriate wire size for a 20 amp circuit.

2. The circuit breaker correctly feeds a single A.C. outlet but the neutral is common between several A.C. outlets.

The common neutral lead must be removed from treadmill's A.C. outlet and a new neutral lead from the treadmill's A.C. outlet to the A.C. neutral distribution bar must be added.

3. Both the hot and neutral leads feed several A.C. outlets.

Both the common neutral and hot leads must be removed from treadmill's A.C. outlet and a new neutral lead and hot lead from the treadmill's A.C. outlet to the A.C. neutral distribution bar and circuit breaker must be added.

240 Vac Systems

240 Vac distribution systems utilize a double pole circuit breaker (two hot leads) The A.C. safety ground (green wire) is connected to a ground bar in the distribution system.

The most common problems found are (1) the circuit is fed by a circuit breaker of less than 20 amp capacity and (2) both the hot leads feed several A.C. outlets. The appropriate correction action or actions (see below) must be followed if any of the above conditions exist. **Corrective actions should only be undertaken by a licensed electrician.**

1. The circuit breaker feeding the treadmill is not a 20 amp circuit breaker.

If the circuit breaker is greater than 20 amps, the circuit breaker should be replaced with a 20 amp circuit breaker. If the circuit breaker is less than 20 amps the circuit breaker must be replaced with a 20 amp circuit breaker and the wiring from the A.C. distribution must be capable of safely handling 20 amps. If the A.C. wiring is under sized, it must be replaced with wire capable of safely handling 20 amps. Please, refer to local electrical codes when determining the appropriate wire size for a 20 amp circuit.

2. Both the hot leads feed several A.C. outlets.

Both hot leads must be removed from treadmill's A.C. outlet and two new hot leads from the treadmill's A.C. outlet to the circuit breaker must be added.

A licensed electrician may use the followings hints to determine if an A.C. service is dedicated.

1. If, on a 120 Vac system, the A.C. distribution panel contains more circuit breakers than neutral leads, the system has shared neutral leads and is not dedicated.
2. If an A.C. outlet (120 or 240 Vac) has multiple hot and/or neutral leads, it is not a dedicated.

If either of the above conditions exist, the system is not dedicated. However, absence of the above conditions does not necessarily mean that the system is dedicated. If any doubt exists about A.C. systems dedication, point to point tracing of the A.C. wiring may be the only way to prove system dedication.

Procedure 5.5 - Troubleshooting the Lift System

Lift System Description:

The lift system on these units consists of an AC line voltage driven lift motor (120 Vac), and an internal 1 K Ω potentiometer for lift position identification. The lift motor contains two motor windings, one to operate the motor in an “upward” direction and the other to operate the motor in a “downward” direction. As the lift motor is operated, the motor also rotates the potentiometer via an internal gear system. Therefore, the position of the lift system can be determined by monitoring the value of the internal potentiometer. The lift motor is initially set at a known starting position (calibration, See Procedure 4.1), subsequent motor movement is tracked via the potentiometer resistance reading.

Note:

All resistance measurements must be performed with power removed from the treadmill. Performing resistance measurements with voltage applied may damage your ohmmeter.

Procedure

1. If the lift motor operates but creates a lift error (error 40 or 42) go to step 16. If the lift motor will not move continue with step 2.
2. Set the treadmill’s circuit breaker in the “off” position and remove the AC line cord from the AC outlet.
3. Remove the F2 (Lift AC) fuse from the lower PCA. Using an ohmmeter, check the resistance of the F2 fuse. See Diagram 5.2. The fuse should measure approximately 0.1 Ω or less. If the fuse is open or high resistance, replace the fuse.

Diagram 5.2 - Lower PCA

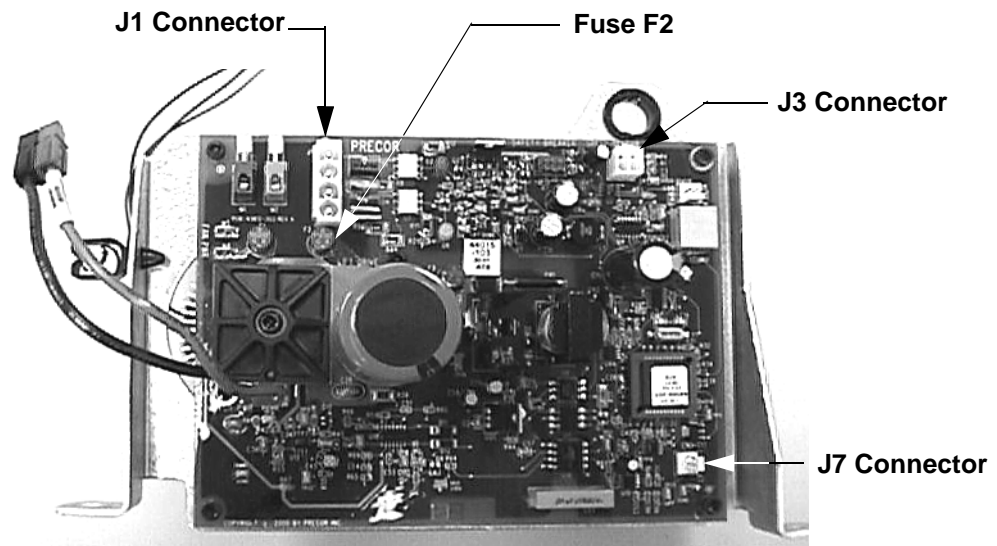

4. Insert the treadmill's line in the AC outlet and set the circuit breaker in the "on" position. Set the treadmill in the manual program and press the **LIFT ▲** key. If the lift motor operates normally, test treadmill operation per Section 3. If the lift motor still does not operate, retest the lift fuse per steps 2 & 3. If the fuse is open again, continue with step 13. If the fuse is good continue with step 5.
5. Connect an AC voltmeter between terminals 1 & 4 of the J1 connector. See Diagram 5.2. Set the treadmill in the manual program and press the **LIFT ▲** key. The AC voltmeter should read AC line voltage (120 Vac) and the red **UP** LED should illuminate. Note that the AC line voltage reading will only be present before an error condition is displayed.
6. If the F2 fuse is good and the **UP** LED illuminates and the AC voltmeter does not read the presence of AC line voltage replace the lower logic PCA per Procedure 6.3.
7. If the **UP** LED does not illuminate and the display indicates that the lift should be moving upward, replace the upper PCA per Procedure 6.8.
8. If the AC voltmeter reads the presence of AC line voltage and an error 40 is displayed, go to step 10.
9. If the AC voltmeter reads the presence of AC line voltage and an error 42 is displayed, continue with step 11.
10. Set the treadmill's circuit breaker in the "off" position and remove the AC line cord from the AC outlet. Remove the lift motor connector from the J1 connector on the lower PCA. Visually inspect the lift motor connector for broken or improperly crimped connections. Using an ohmmeter, read the resistance between terminals 1 & 4 and between terminals 3 & 4. Both readings should be approximately 12 Ω . If either reading is open or very high resistance, replace the lift motor per Procedure 6.1.
11. Set the treadmill's circuit breaker in the "off" position and remove the AC line cord from the AC outlet. Remove the lift motor connector from the J7 connector on the lower PCA. Visually inspect the lift motor connector for broken or improperly crimped connections. Using an ohmmeter, measure between terminals 1 & 3, 1 & 2 and 2 & 3 of the lift motor connector. Terminals 1 and 3 should read approximately 1 K Ω . The sum of the two readings between terminals 2 & 3 and 1 & 2 should total approximately 1 K Ω . If either reading is open or very high resistance, replace the lift motor per Procedure 6.1.
12. If you have performed all of the procedures above and have been unable to correct the problem, call Precor customer service.
13. Set the treadmill's circuit breaker in the "off" position and remove the AC line cord from the AC outlet. Remove the lift motor connector from the J1 connector on the lower PCA. Visually inspect the lift motor connector for broken, frayed or improperly crimped connections. Using an ohmmeter, read the resistance between terminals 1 & 4, 3 & 4 and 1 & 3. The readings should be approximately 12 Ω , 12 Ω and 24 Ω , respectively. If the reading is significantly low, replace the lift motor per Procedure 6.1.

14. If the resistance readings in step 13 are normal, replace the lower logic PCA per Procedure 6.3.
15. If you have performed all of the procedures above and have been unable to correct the problem, call Precor customer service.
16. Set the treadmill's circuit breaker in the "off" position and remove the AC line cord from the AC outlet. Remove the lift motor connector from the J7 connector on the lower logic PCA. Visually inspect the lift motor connector for broken or improperly crimped connections. Using an ohmmeter, measure between terminals 1 & 3, 1 & 2 and 2 & 3 of the lift motor connector. Terminals 1 and 3 should read approximately 1 K Ω . The sum of the two readings between terminals 2 & 3 and 1 & 2 should total approximately 1 K Ω . If either reading is open or very high resistance, replace the lift motor per Procedure 6.1.
17. If the resistance measurements in step 16 are normal, the problem may be either the lower logic PCA or the upper PCA. Replace the lower logic PCA. If the problem persists, reinstall the original lower logic PCA and replace the upper PCA.

If you have performed all of the procedures above and have been unable to correct the problem, call Precor customer service.

Procedure 5.6 - Running Belt & Deck Troubleshooting

This procedure is to be used to determine the condition of the running belt and running deck combination. A clamp-on ammeter will be used to measure the treadmill's A.C. input current under load. The A.C. input current is a direct indication of the load being placed on the treadmill. Treadmill loading consists of several factors, the user's weight, treadmill speed, treadmill incline setting and the condition of the running belt and running deck condition. By making all of the other factors consistent we will be able to determine the relative condition of the running belt and deck combination. The A.C. input current measurements will be performed at 3 m.p.h. (4.8 k.p.h.) and 0% incline. Because the loading varies with the user's weight, you should perform the A.C. input current measurement test on a new running belt and deck combination. That will provide you with a benchmark reading to account for your individual weight.

Because the A.C. input current reading will pulse between a high value (during foot plant) and a low reading (between foot plants) we suggest the use of an analog clamp-on ammeter. An analog ammeter makes it very easy to see the A.C. current pulses. The refresh rate on digital ammeters may make it difficult to see the current peaks.

1. Remove the treadmill's motor cover and place the A.C. clamp-on ammeter on the brown wire from the A.C. input module (or A.C. power cord) to the circuit breaker (on/off switch). See the illustration below.

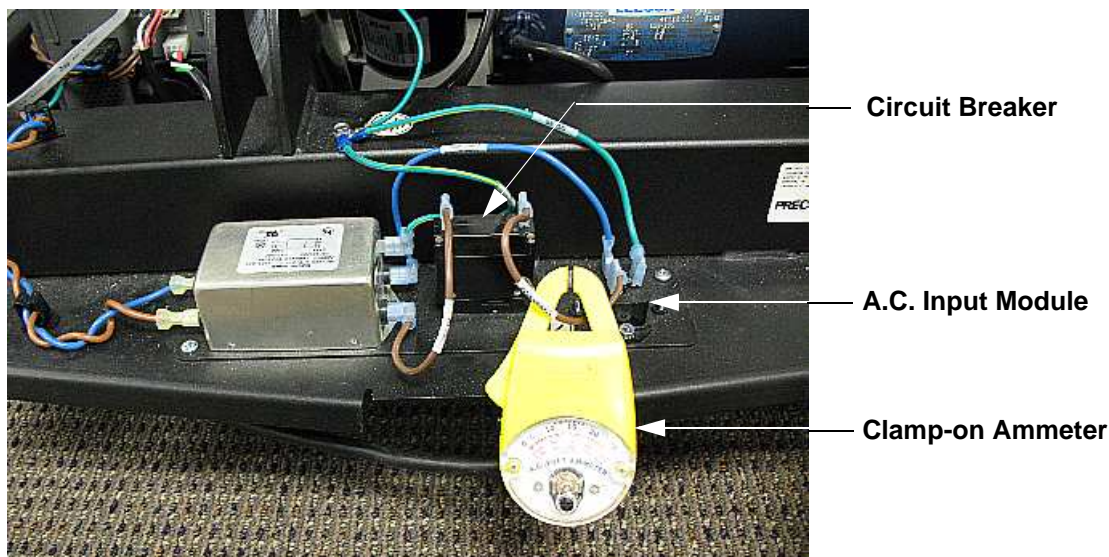

2. Set the treadmill's speed at 3 m.p.h. (4.8 k.p.h.) and the incline at 0%. Walk on the treadmill and observe the peak A.C. current reading. Typical peak A.C. current readings on a new running belt and deck are between 3 and 6 amperes.
3. If the peak current reading approach 20 amperes, the running belt should be replaced. The running deck should be flipped or replaced if the running deck has been previously flipped. See Procedure X for running belt and running deck replacement.

4. If the peak A.C. current readings are greater than on a new running belt and deck combination but not approaching 20 amperes, the reading will give you an indication of the running belt and deck combination's general condition.

Procedure 6.1 — Replacing the Lift Motor

Note:

The replacement lift motor must be calibrated prior to installation. The lower PCA bracket assembly must be removed to gain access to the lift motor. The defective lift motor is then removed and the calibrated replacement lift motor is installed. The lower PCA bracket is then replaced.

1. If the incline is at 0%, skip to step 3.
2. Set the treadmill circuit breaker in the “on” position. Press the **QUICK START** to start the running belt. Use the **INCLINE ▼** key to lower the incline to -3%
3. Set the treadmill circuit breaker in the “off” position and remove the AC line cord from the AC outlet.
4. Disconnect the lift motor plugs from J2 and J5 connectors of the lower logic PCA. See Diagram 5.2.
5. Lay the replacement lift motor on the floor in front of the treadmill and connect it's two plugs to the J2 & J5 connectors of the lower logic PCA.
6. Calibrate the lift motor per Procedure 4.1, steps 4-7.
7. Remove the lower PCA per Procedure 6.4, steps 1-7.
8. Remove the defective lift motor as follows: remove the screw that fastens the frame ground wire (green with yellow stripe) to the treadmill frame. Remove the hitch and clevis pins from the top and bottom of the lift motor. Remove the lift motor from the treadmill.
9. Set the calibrated lift motor in its mounting position. Replace the upper clevis and hitch pins.
10. Replace the lower clevis and hitch pins. It may be necessary to slightly rotate the lift tube to align it so that the clevis pin may be inserted. To align the hole in the lift tube rotate it in the direction that will cause the least amount of rotation to make alignment possible.
11. Connect the frame ground wire to the treadmill frame with the screw removed in step 6. Route both lift motor cables as noted in the lift motor removal procedure.
12. Replace the lower PCA per Procedure 6.4, steps 8-12.
13. Route the lift motor cables to the lower logic PCA as noted during the previous removal procedure. Plug the lift motor plugs into the J2 & J5 connectors on the lower logic PCA.
14. Check treadmill operation per Procedure 3.

Procedure 6.2 — Replacing the Lift Platform

1. Set the treadmill circuit breaker in the “off” position. Remove the AC line cord from the AC outlet.
2. Remove the treadmill hood. Carefully, lay the treadmill on it's right side.
3. Remove the hitch pin and clevis pin that fastens the lift motor tube to the lift platform. While the lift tube is not fastened to the lift platform, care must be taken to not allow the lift tube to rotate. If the lift tube rotates, the lift motor must be re-calibrated per Procedure 4.1.
4. Remove the lift platform retaining bolt from both the left and right hand side of the lift platform. See diagram 6.1.

Diagram 6.1 - Lift Platform Mounting)

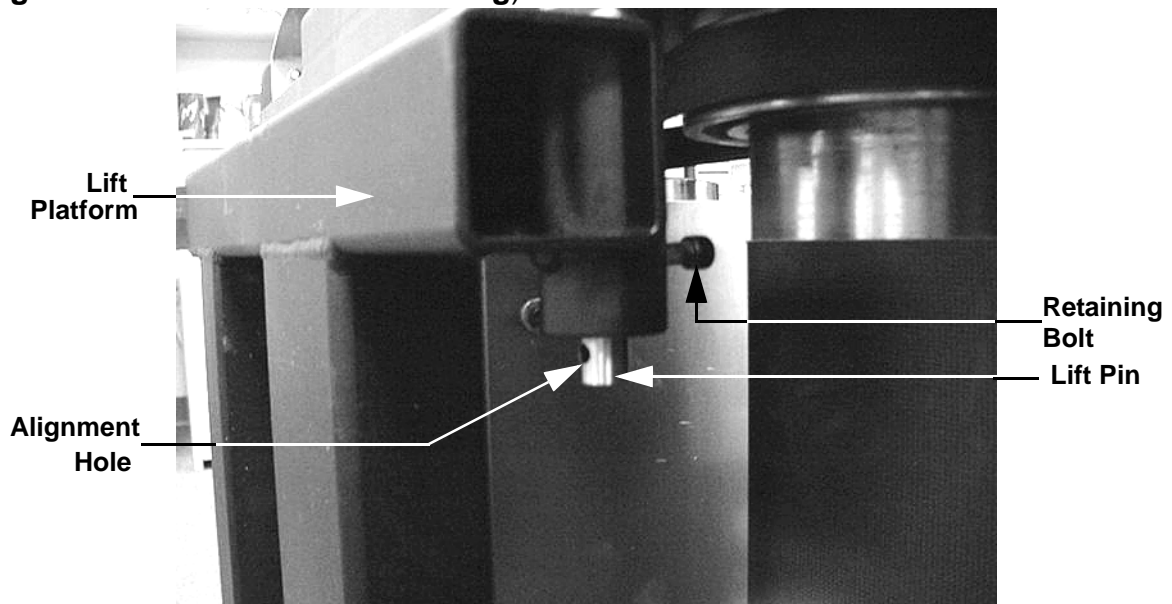

5. Slide a 5/32 inch allen wrench or similar slender tool into the alignment hole as shown in Diagram 6.2. Pull the right hand (lower) lift pin out of the treadmill frame.

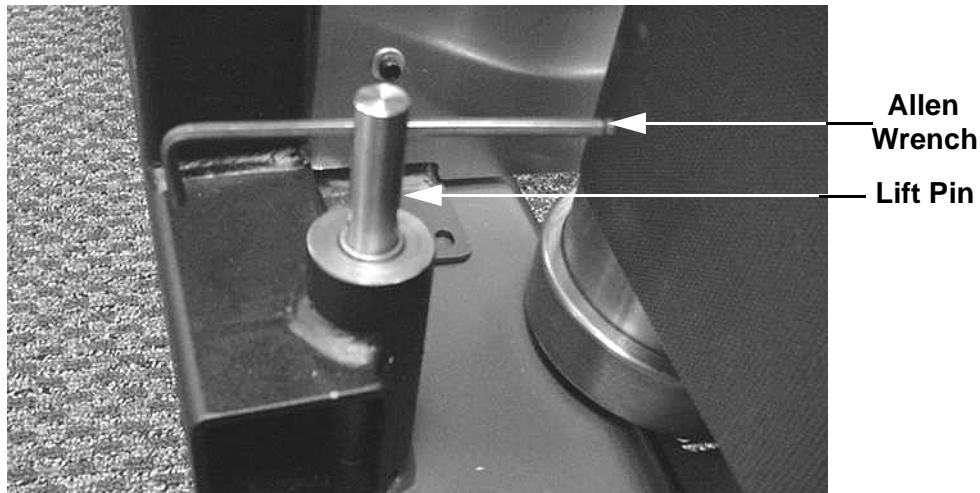
Diagram 6.2 - Lift Pin Removal

6. Pull the left hand (upper) lift pin out of the treadmill frame in the same manner as in step 5. Remove the lift platform from the treadmill.
7. Remove both wheels from the lift platform and re-mount them on the replacement lift platform.
8. Set the replacement lift platform in its mounting position. Slide the allen wrench into the right hand lower lift pin alignment hole as shown in Diagram 6.2. Carefully, align the lift pin with its mating bushing in the treadmill frame and tap the lift platform into the frame bushing with a rubber mallet. The pin should be in as far as possible while still allowing the allen wrench to be easily removed.
9. Slide the allen wrench into the left hand (upper) lift pin alignment hole and tap the lift pin into its frame bushing as described in step 8.
10. Slide the retaining bolt into its mounting hole and apply slight inward pressure on the retaining bolt. Rotate the lift pin using the allen wrench until you feel the retaining bolt “drop” into its chamfered and threaded hole in the lift pin. Hand thread the retaining bolt into the lift pin as far as possible. Care must be taken to ensure that you do not cross thread the retaining bolt.
11. Hand thread the right hand (lower) retaining bolt into the lift platform as described in step 10.
12. Tighten both lift platform retaining bolts.
13. Fasten the lift motor tube to the lift platform with the clevis pin and hitch pin removed in step 3.
14. Check treadmill operation per Procedure 3.
15. Set the replacement lower power PCA in its mounting position. Note that the lip on the lower power PCA heat sink fits over the center wall of the mounting bracket.

Procedure 6.3 — Replacing the Speed Sensor

1. Set the treadmill circuit breaker in the “off” position. Remove the AC line cord from the AC outlet.
2. Disconnect the plug from the J2 connector on the lower logic PCA.
3. Rotate the flywheel so that the speed sensor is between flywheel lobes.
4. Remove the screws that fastens the speed sensor mounting bracket to the treadmill drive motor. See Diagram 6.3.

Diagram 6.3 — Speed Sensor Mounting

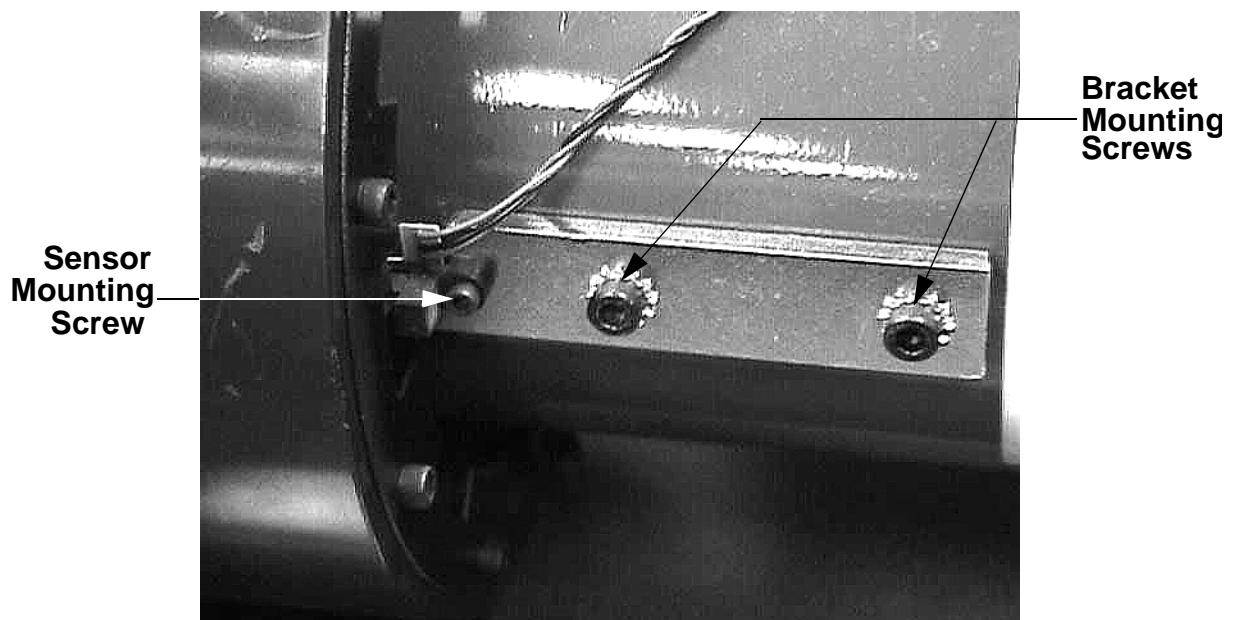

5. Remove the mounting bracket from the drive motor.
6. Remove the two screws that fasten the speed sensor to the bracket.
7. Mount the replacement speed sensor on the mounting bracket with the screws removed in step 6.
8. Mount the bracket on the drive motor with the screws removed in step 4.
9. Insert the speed sensor plug into the J2 connector on the lower logic PCA.
10. Slowly rotate the flywheel to ensure that the flywheel lobes do not contact the speed sensor.

11. Set the treadmill circuit breaker in the "on" position and check treadmill operation per Procedure 3.

Procedure 6.4 — Replacing Drive Motor

1. Set the treadmill circuit breaker in the “off” position and unplug the treadmill’s line cord from the AC outlet.
1. Remove the hood.
2. The drive motor and flywheel are balanced as a matched pair. Since the flywheel is balanced to a specific motor, flywheels should not be removed from one and installed on a different motor. If the drive motor is replaced, the drive motor and flywheel should be replaced as a unit.
3. Disconnect the wires from the drive motor cooling fan. Disconnect the speed sensor connector from the J2 connector on the lower PCA. Disconnect the drive motor’s in-line connector located in the drive motor wires.
4. Remove the drive belt tension bolt, see Diagram 4.2. Rotate the drive motor as far as possible toward the rear of the treadmill.
5. Remove the drive belt from the drive motor pulley.
6. Remove the four bolts that fasten the drive motor onto it’s mounting plate. Remove the drive motor from the treadmill.
7. Remove the screws that mount the speed sensor and bracket onto the drive motor, see Diagram 6.9.
8. Mount the speed sensor and bracket on the replacement drive motor using the screws removed in step 7.
9. Remove the four screws that fasten the drive motor cooling fan onto the drive motor. See Diagram 6.13.
10. Mount the drive motor cooling fan onto the replacement drive motor with the screws removed in step 9.
11. Set the drive motor in it’s mounting position. Fasten the drive motor to it’s mounting plate using the bolts removed in step 6.
12. Set the drive belt in place on the drive motor pulley.
13. Rotate the drive motor forward and replace the drive belt tension bolt removed in step 4. Tension the drive belt per procedure 4.2.
14. Connect the brown and blue fan wires to the drive motor cooling fan. The blue and brown wires can be connected to either terminal. Reconnect the drive motor in-line connector. Reconnect the speed sensor to the J2 connector of the lower logic PCA.

15. Re-install the hood.
16. Check treadmill operation per Procedure 3.

Procedure 6.5 — Replacing the Circuit Breaker

1. Set the treadmill circuit breaker in the “off” position and unplug the treadmill’s line cord from the AC outlet.

Diagram 6.4 — Circuit Breaker Mounting Panel

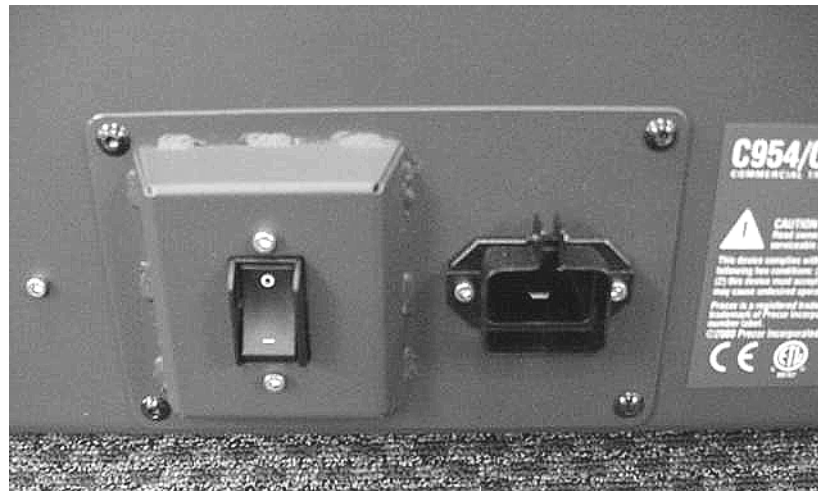

2. Disconnect all of the wiring from the circuit breaker.
3. Remove the circuit breaker mounting screws. Remove the circuit breaker from the treadmill.
4. Set the replacement circuit breaker in its mounting position. Fasten the circuit breaker to the circuit breaker mounting panel using the screws removed in step 4.
5. Connect the wiring to the circuit breaker per Diagram 6.5.

Diagram 6.5 — Circuit Breaker Wiring

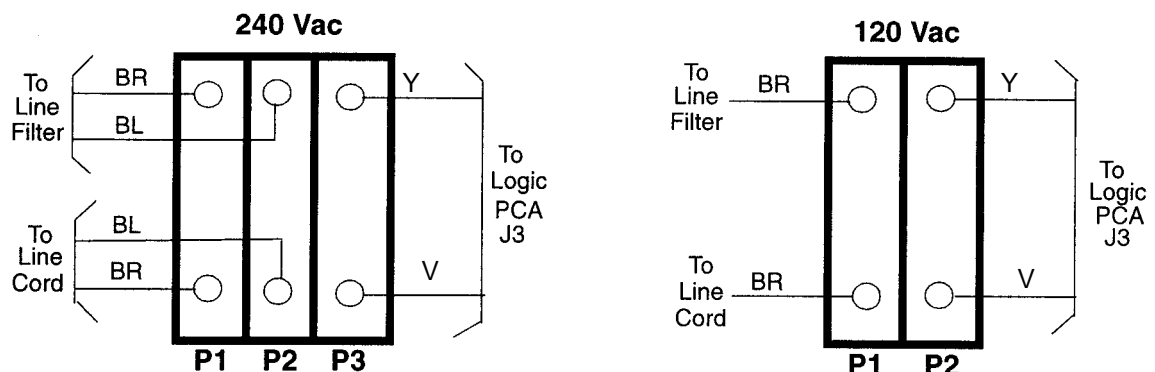

6. Set the circuit breaker mounting panel in its mounting position. Fasten the circuit breaker mounting panel to the treadmill using the screws removed in step 2.
7. Check treadmill operation per Section 3.

Procedure 6.6 — Replacing the Line Filter

1. Set the treadmill circuit breaker in the “off” position and unplug the treadmill’s line cord from the AC outlet.
2. Remove the four screws that fasten the circuit breaker mounting plate to the treadmill. See Diagram 6.10 or 6.11.
3. Disconnect all of the wiring from the line filter.
4. Remove the screws that fasten the line filter to the circuit breaker mounting panel.
5. Set the replacement line filter in it’s mounting position. Fasten the line filter to the circuit breaker mounting panel with the screws removed in step 4.
6. Connect the wiring to the line filter per Diagram 6.13.

Diagram 6.6 — Line Filter Wiring

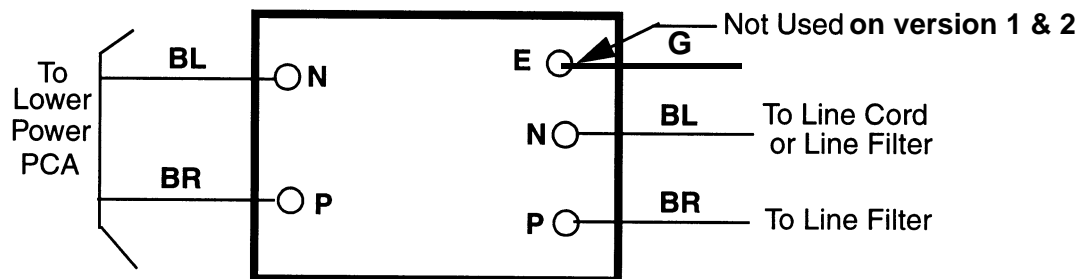

7. Set the circuit breaker mounting panel in it’s mounting position. Fasten the circuit breaker mounting panel to the treadmill using the screws removed in step 2.
8. Check treadmill operation per Section 3.

Procedure 6.7 — Replacing the Line Cord

1. Set the treadmill circuit breaker in the “off” position and unplug the treadmill’s line cord from the AC outlet.
2. These units are equipped with a detachable line cord. Loosen the line cord clamping screw. See Diagram 6.7.

Diagram 6.7 - Detachable Line Cord

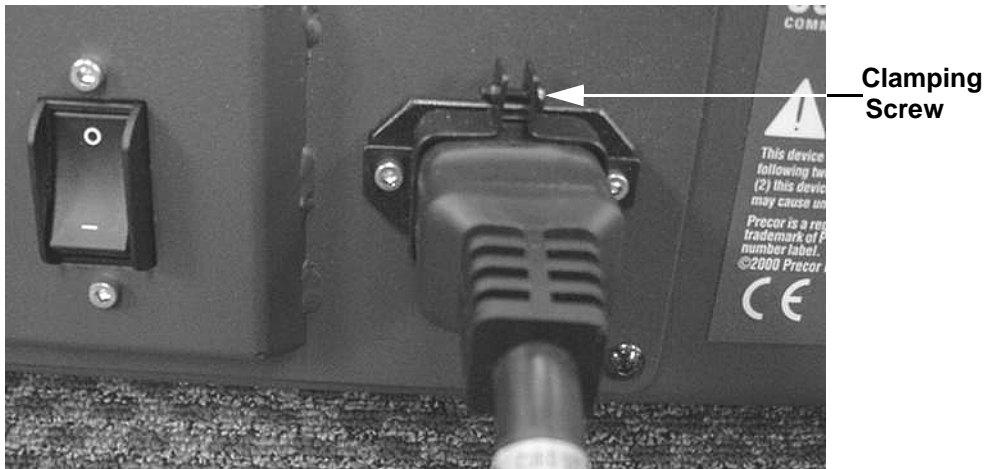

3. Remove the line cord from the line cord socket.
4. Insert the replacement line cord in the line cord socket, be sure that the line cord is fully engaged with the line cord socket. Tighten the line cord socket clamping screw. It is extremely important that the line cord is fully engaged in the line cord socket. A poor connection between the line cord and line cord socket can generate enough heat to damage the line cord and/or line cord socket.
5. Check treadmill operation per Section 3.

Procedure 6.8 — Replacing the Drive Motor Cooling Fan

1. Set the treadmill circuit breaker in the “off” position and unplug the treadmill’s line cord from the AC outlet.
2. Remove the hood.
3. Remove the drive motor per Procedure 6.4, steps 2-8.
4. Remove the four screws that mount the drive motor cooling fan to the drive motor. See Diagram 6.8

Diagram 6.8 — Drive Motor Cooling Fan Mounting

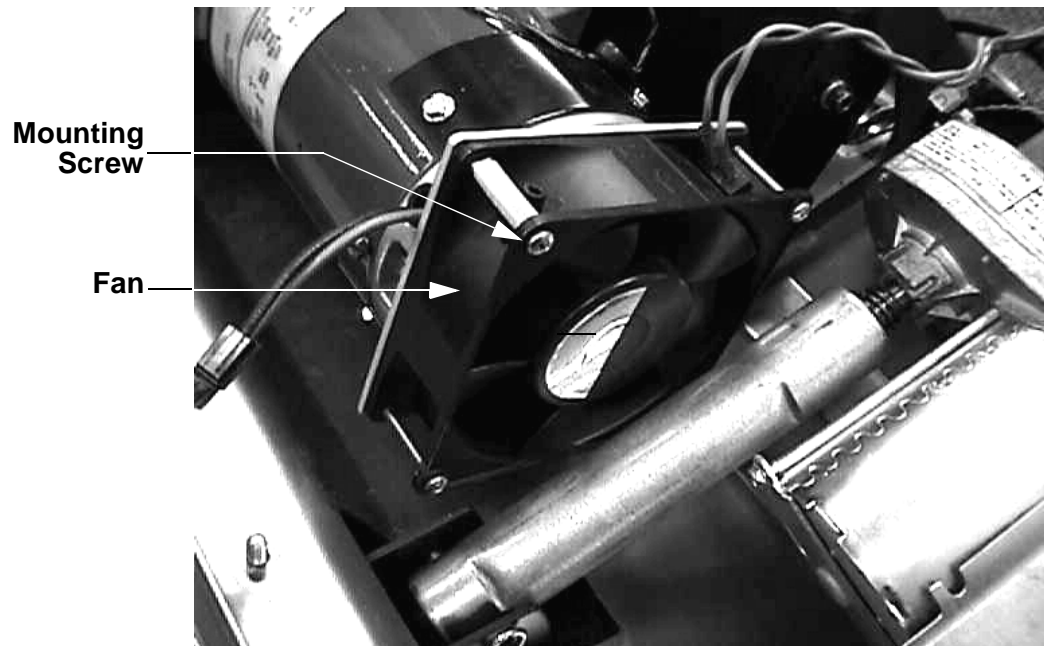

5. Set the replacement drive motor cooling fan at it's mounting position on the drive motor and fasten it with the hardware removed in step 4.
6. Replace the drive motor per Procedure 6.4, steps 11-15.
7. Check treadmill operation per Procedure 3.

Procedure 6.9 — Replacing the Drive Motor Brushes

1. Set the treadmill circuit breaker in the “off” position and unplug the treadmill’s line cord from the AC outlet.
1. Remove the hood.
2. Remove the drive motor per Procedure 6.4, steps 2-6.
3. Remove the screws that retain the drive motor brush cover. Carefully, remove the heavy paper cover from the brush access opening.
4. Disconnect the brush wire from the tab on the brush housing. Remove the brush spring by depressing the tab on the brush spring.
5. Remove the brush from it’s brush holder. See Diagram 6.9.

Diagram 6.9 — Drive Motor Brush

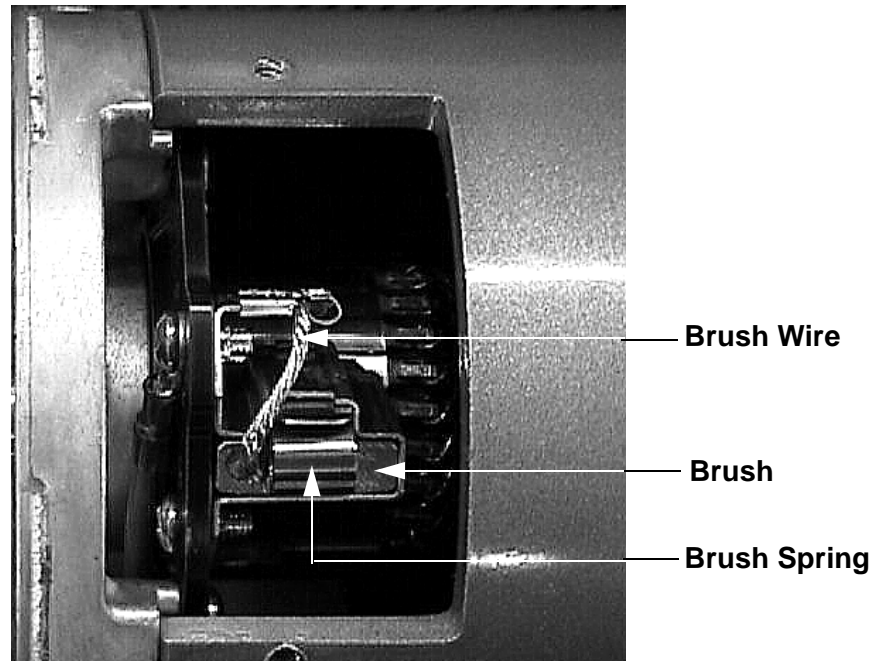

6. Slide the replacement brush into the brush holder. Be sure that the angled edge of the brush is oriented so that the brush face makes full contact with the motor commutator.
7. Reinstall the brush spring and connect the brush wire to the tab on the brush holder.
8. Replace the heavy paper cover in the brush access opening. Replace the brush cover and fasten it with the screws removed in step 3.

Procedure 6.10 — Replacing the Lower PCA

1. Set the treadmill circuit breaker in the “off” position. Remove the AC line cord from the AC outlet.
2. Note the routing and tie down points of all of the wiring coming into the lower PCA. This information will be required after the replacement lower PCA has been installed. It is important to have the cabling correctly routed and tied down.

Diagram 6.10 — Lower PCA Mounting

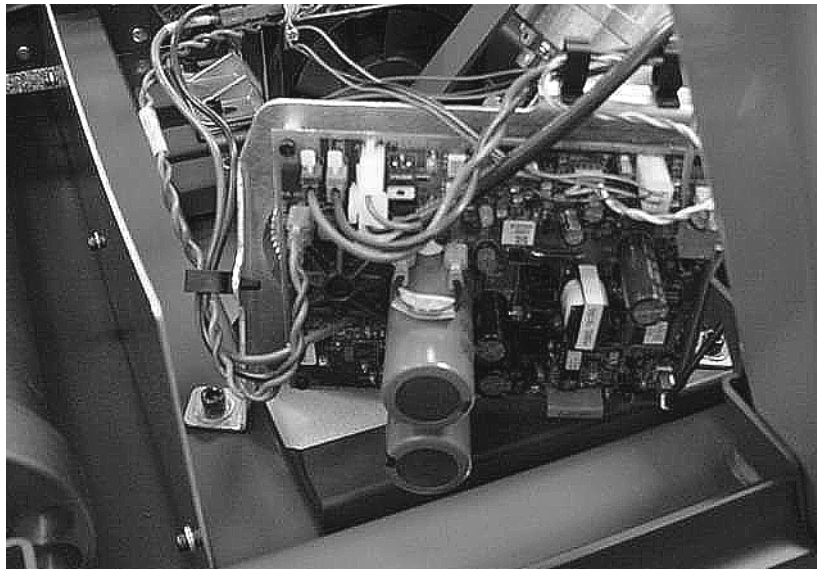

3. Remove the two bolts that fasten the lower PCA to the frame. Remove the lower PCA.
4. Set the replacement lower PCA at its mounting position and fasten it with the bolts removed in step 3.
5. Re-connect and cable tie all of the lower PCA wiring as noted in step 2.
6. Set the treadmill circuit breaker in the “on” position and check treadmill operation per Procedure 3.

Procedure 6.11 - Replacing the PROM

Anti-static kits (part number 20024-101) can be ordered from Precor.

1. The PROM and the associated printed circuit assembly (PCA) are static sensitive. Anti-static devices must be used and all anti-static precautions must be followed during this procedure.
2. Remove the printed circuit assembly per its associated procedure.
3. Currently we are using two styles of IC software packages. they are a 28 pin dual in line package (DIP28) and a forty-four pin square package (PLCC44). Each of these packages should be removed with a proper IC removal tool (see the illustrators below)

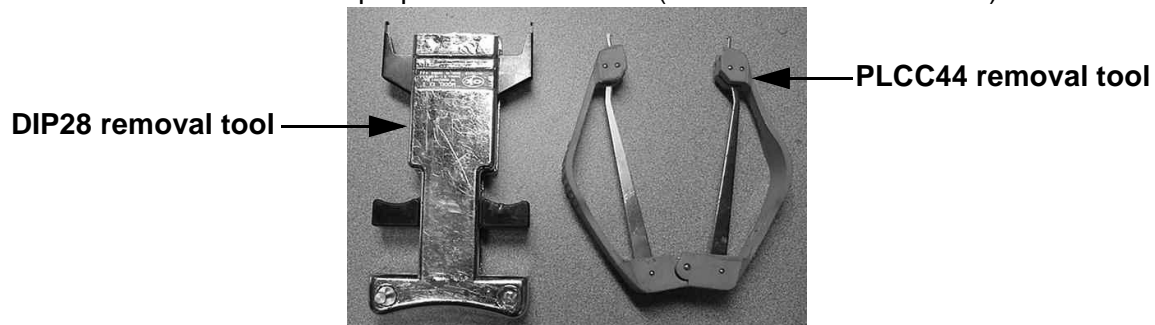

4. The IC's may inserted into their socket by hand by carefully aligning the notch on the IC with the notch on the IC socket and carefully pressing the IC into its socket. See the illustrations below for the alignment notches. Care must be taken that the IC legs on a DIP28 are all aligned in the socket to prevent the legs from bending when inserted. The PLCC44 IC must be carefully aligned squarely in its socket or it will not insert. Do not force the IC into its, socket. If it does not insert easily, remove the it and re-align it in its socket.

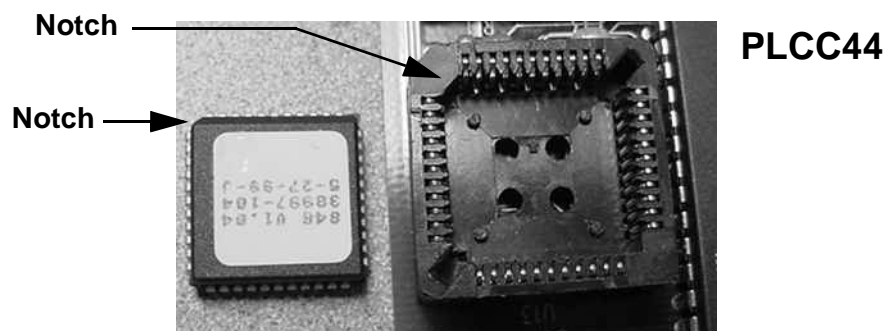
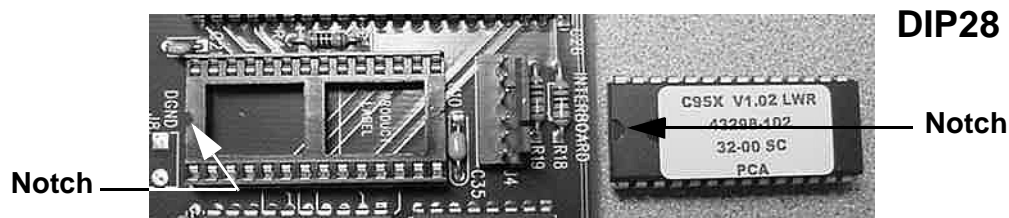

Procedure 6.12 - Drive Roller Replacement

Note: Two running belt gauges, Precor part number 20007-101, are required. It is important that this procedure be followed to maintain correct drive belt and running belt tension. Over tensioning the belt will lead to premature running belt wear, premature driver roller bearing failure and premature take up roller bearing failure.

Drive Roller Removal

1. Remove the end caps from the rear of treadmill to expose the take up roller mounting bolts. Remove the treadmill's motor cover.
2. Remove the deck trim from both sides.
3. Loosen, but do not remove the take up roller mounting bolts. The bolts are being loosened to remove tension from the running belt.
4. Slowly rotate the drive motor flywheel while pressing the drive belt off of the drive roller pulley.
5. Continue until the drive belt walks completely off of the drive roller pulley.
6. The left side drive roller shaft is flush with the front of the bracket and the right side is not. Using a measuring tape, measure the front of the shaft to the front frame cross beam on both sides. Make note of this measurement. Using this measurement will ensure that the roller is parallel and square with the front of the frame when the roller is installed.

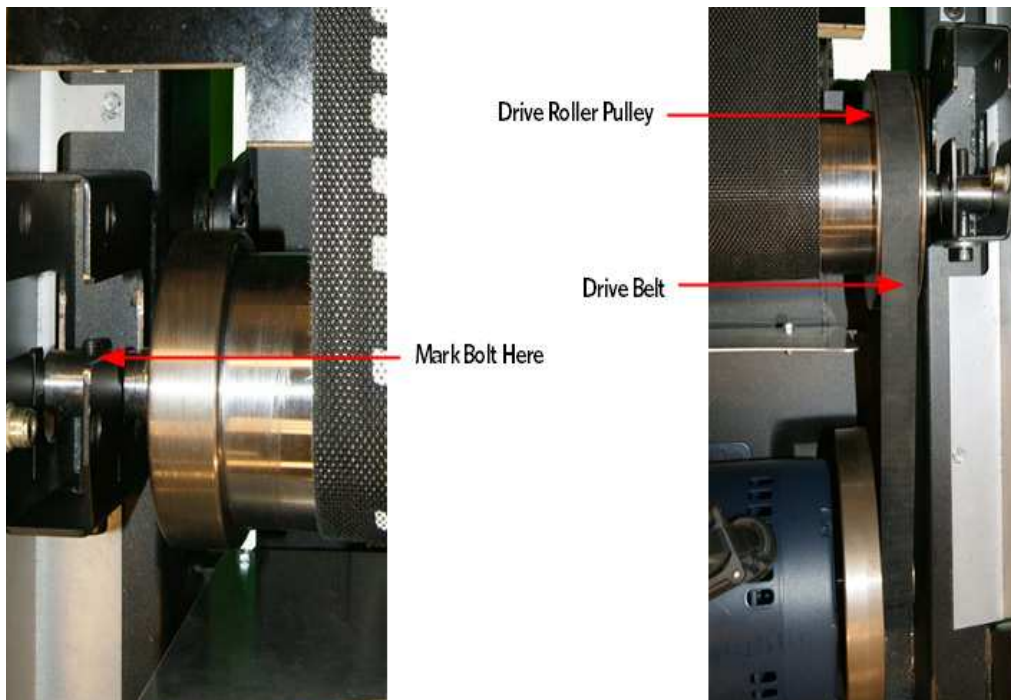

7. Remove both drive roller mounting bolts releasing the tension evenly on both sides. Remove the drive roller from the treadmill using the drive belt as a handle.

Installing the Drive Roller

8. Place the drive belt on the new drive roller and use as a handle to slide the drive roller through the running belt and into place. Hand start both drive roller mounting bolts.
9. Make sure the running belt is in the center of the deck with the same amount of space on each corner of the deck running belt combo.
10. Start tightening the bolts on the drive roller. The left side will tighten flush with the front of the bracket. Tighten the right side bolt until it reaches the measurement previously noted in step 5. The drive roller should now be square with the front frame cross beam.
11. Rotate the drive motor flywheel to walk the drive belt onto the drive roller pulley. Be sure the belt is fully onto both pulleys and correctly aligned. A drive belt tension gauge should read 100-120 pounds. The drive belt de-tension after use. A range of 80-90 pounds after the belt has been installed for a while is acceptable.

Tensioning the Running Belt

12. Move the running belt so that the seam is underneath the treadmill. Then place the two running belt tension gauges on each side of the running belt parallel from each other. One side of the gauge is fixed while the other moves. Place the gauge in the middle of its travel and put the hand on number 3. The face of the gauge can fine tune to get the hand exactly

on 3.



13. Move the running belt carefully so that you can see the dials easily. Alternate tightening the take up roller mounting bolts in order to tighten both ends evenly until the gauges read .55% which are five and half lines pass the number 3.

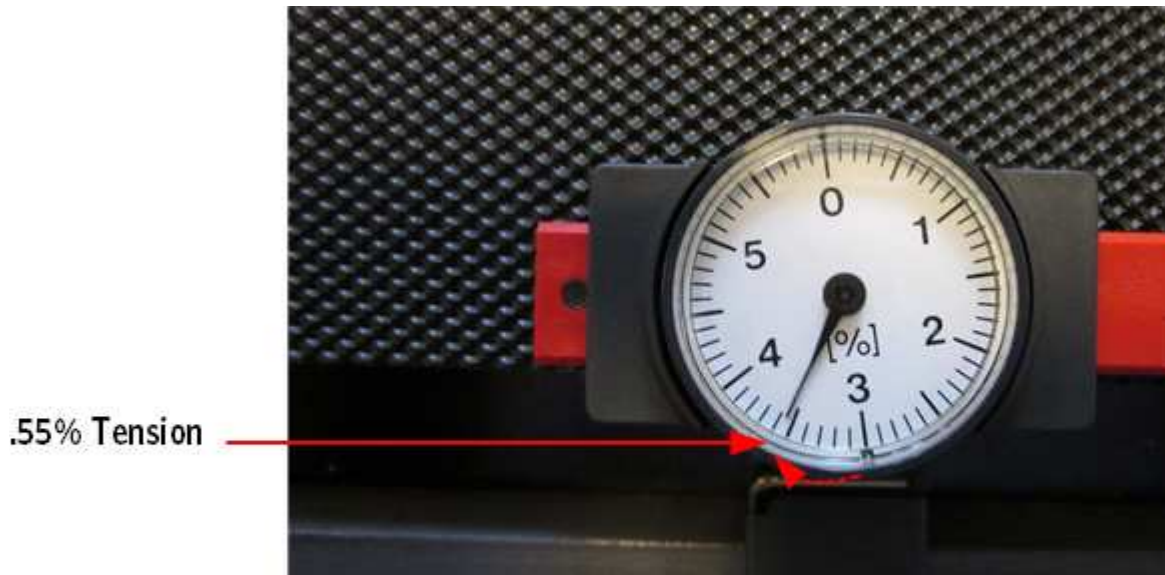

14. Remove both gauges from the running belt.

Running Belt Tracking Adjustment

15. Start the treadmill and operate at 1 mph. Observe the running belt and place a marker on one side. If the belt starts to drift toward the right, slowly turn the right side take up roller mounting bolt clockwise until the drifting stops. If the belt starts to drift toward the left, slowly turn the right side take up roller mounting bolt counterclockwise until the drifting stops. The adjustments should only be done in 1/4 turn increments. NOTE: ONLY use the right side take up roller mounting bolt to adjust tracking.

16. Increase the speed to 3 mph for a minute, then 6 mph, 9 mph and finally 12 mph. Making any small adjustments as needed.
17. Set the treadmill speed to 3 mph for a couple of minutes walking on the running belt. Verify that the belt has not moved. Adjust the right side take up roller mounting bolt if needed to make final adjustments.
18. Replace the end caps or rear guard and motor cover.

Procedure 6.13 - Take Up Roller Replacement

Note: Two running belt gauges, Precor part number 20007-101, are required. It is important that this procedure be followed to maintain correct drive belt and running belt tension. Over tensioning the belt will lead to premature running belt wear, premature driver roller bearing failure and premature take up roller bearing failure.

1. Remove the end caps or rear guard from the rear of the treadmill to expose the take up roller mounting bolts. Remove the treadmill motor cover.
2. Remove the deck trim from both sides.
3. Walk the drive belt off the drive roller and motor pulleys.
4. The left side drive roller shaft is flush with the front of the bracket and the right side is not. Using a measuring tape, measure the front of the shaft to the front frame cross beam on both sides. Make note of this measurement. Using this measurement will ensure that the roller is parallel and square with the front of the frame when the roller is installed.
5. Loosen, but do not remove the drive roller mounting bolts. Release the tension evenly on both sides. These bolts are being loosened to remove the tension on the running belt.
6. If applicable, remove the rear roller guards located in the front of the take up roller.
7. Remove the take up roller mounting bolts by releasing the tension evenly on both sides. Then lift and slide the take up roller out.

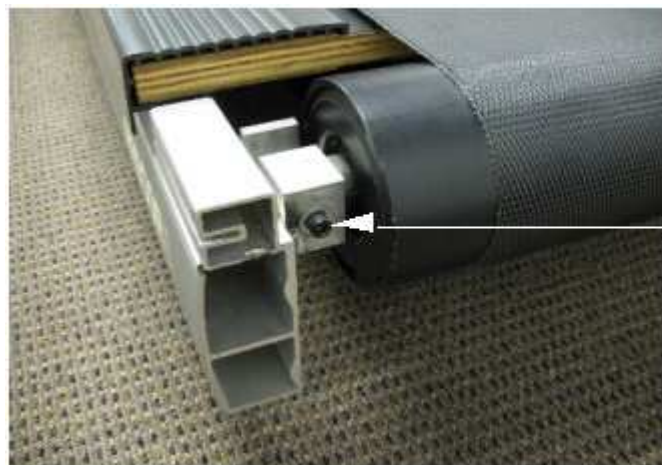

**Take Up Roller
Mounting Bolt**

8. Slide the new take up roller through the running belt and into place. Hand start both take up roller mounting bolts a few turns only.
9. Make sure the running belt is in the center of the deck with the same amount of space on each corner of the deck running belt combo.

10. Start tightening the bolts on the drive roller. The left side will get tighten flush with the front of the bracket. Tighten the right side bolt until it reaches the measurement previously noted in step 5. The drive roller should now be square with the front frame cross beam.
11. Rotate the drive motor flywheel to walk the drive belt onto the drive roller pulley. Be sure the belt is fully onto both pulleys and correctly aligned. A drive belt tension gauge should read 100-120 pounds. The drive belt de-tension after use. A range of 80-90 pounds after the belt has been installed for a while is acceptable.
12. Move the running belt so that the seam is underneath the treadmill. Then place the two running belt tension gauges on each side of the running belt parallel from each other. One side of the gauge is fixed while the other slides side to side. Place the movable side in the middle of its travel and adjust the dial pointer exactly on number 3.

NOTE: Using the number 3 is a reference point only. When the movable side is in the center of travel on the gauge it allows room for increments or decrements.



13. Move the running belt carefully so that you can see the dials easily. Tighten the take up roller mounting bolts alternately in order to tighten both ends evenly. Tighten until the gauges read .55%, which are five and 1/2 lines past the number 3.



Running Belt Tracking Adjustment

14. Start the treadmill and operate at 1 mph. Observe the running belt and place a marker on one side. If the belt starts to drift toward the right, slowly turn the right side take up roller mounting bolt clockwise until the drifting stops. If the belt starts to drift toward the left, slowly turn the right side take up roller mounting bolt counterclockwise until the drifting stops. The adjustments should only be done in 1/4 turn increments. NOTE: ONLY use the right side take up roller mounting bolt to adjust tracking.
15. Set the treadmill speed to 3 mph for a couple of minutes walking on the running belt. Verify that the belt has not moved. Adjust the right side take up roller mounting bolt if needed to make final adjustments.
16. Set the treadmill speed to 3 mph for a couple of minutes walking on the running belt. Verify that the belt has not moved or adjust if necessary on the right side take up roller mounting bolt only.
17. Replace the end caps or rear guard and motor cover.

Procedure 6.14 - Running Belt and/or Deck Replacement

Note: Two running belt gauges, Precor part number 20007-101, are required. It is important that this procedure be followed to maintain correct drive belt and running belt tension. Over tensioning the belt will lead to premature running belt wear, premature driver roller bearing failure and premature take up roller bearing failure.

1. Remove the end caps from the rear of treadmill to expose the take up roller mounting bolts. Remove the treadmill's motor cover.
2. If applicable, remove the finger guard from in front of the take up roller.
3. Remove both running deck trim strips and both take up roller mounting bolts. Remove the take up roller from the treadmill.

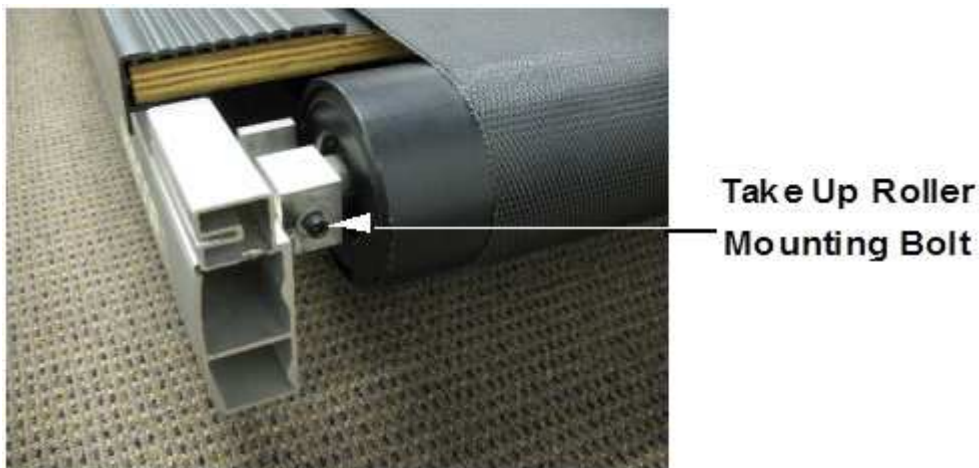

4. Slowly rotate the drive motor flywheel while pressing the drive belt off of the drive roller pulley. Continue until the drive belt walks completely off of the drive roller pulley.

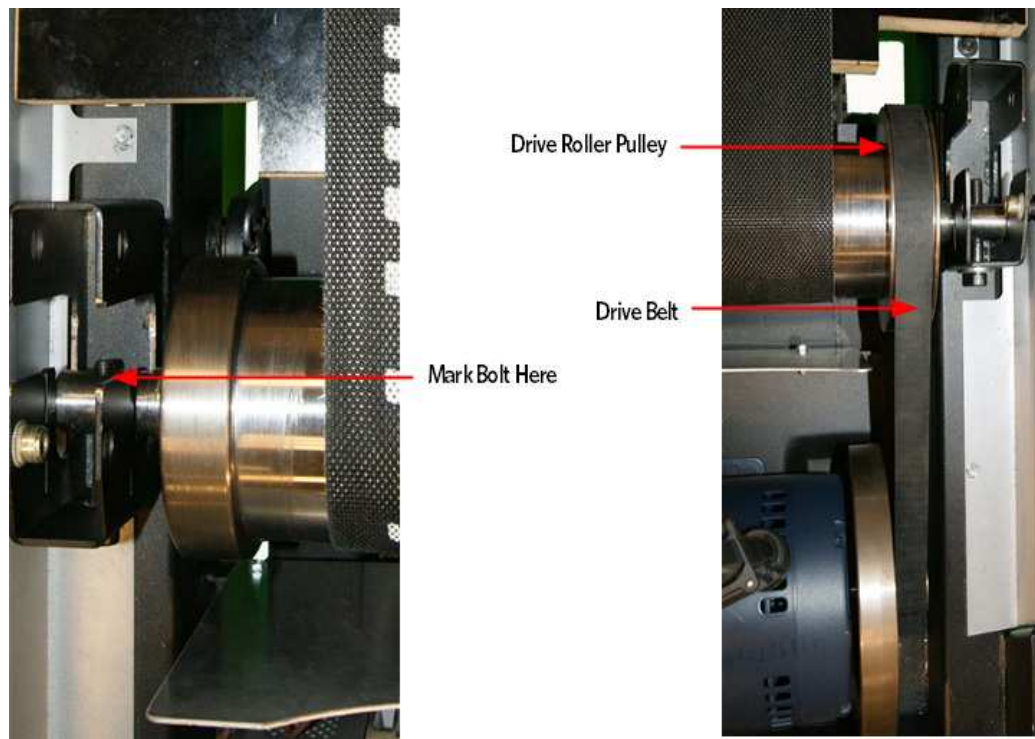

5. Remove the 4 bolts and the retaining plates that hold the deck to the frame. Lift the deck and running belt combo up and away from the treadmill.



6. The left side drive roller shaft is flush with the front of the bracket and the right side is not. Using a measuring tape, measure the front of the shaft to the front frame cross beam on both sides. Make note of this measurement. Using this measurement will ensure that the roller is parallel and square with the front of the frame when the roller is installed.

7. Remove both drive roller mounting bolts releasing the tension evenly on both sides. Remove the drive roller from the treadmill using the drive belt as a handle.
8. Remove the Auto Stop magnet from the deck, if applicable. Slip the running belt off the deck and discard. Remove the inserts from the deck and flip it over. re-insert them into the new deck surface. If the deck has already been flipped replace it with a new deck. Make sure that the new deck surface is clear of debris. Ensure the new deck is installed with the inserts on the bottom of the deck.
9. The new running belt will have an arrow pointing in one direction on the underside. The arrow indicates the correct direction of travel for the belt. Premature belt failure will occur if the belt is installed incorrectly. Slip the new running belt onto the deck and carefully place them back onto the treadmill.



10. Reinstall the Auto Stop magnet on the right front corner of the deck, if applicable.

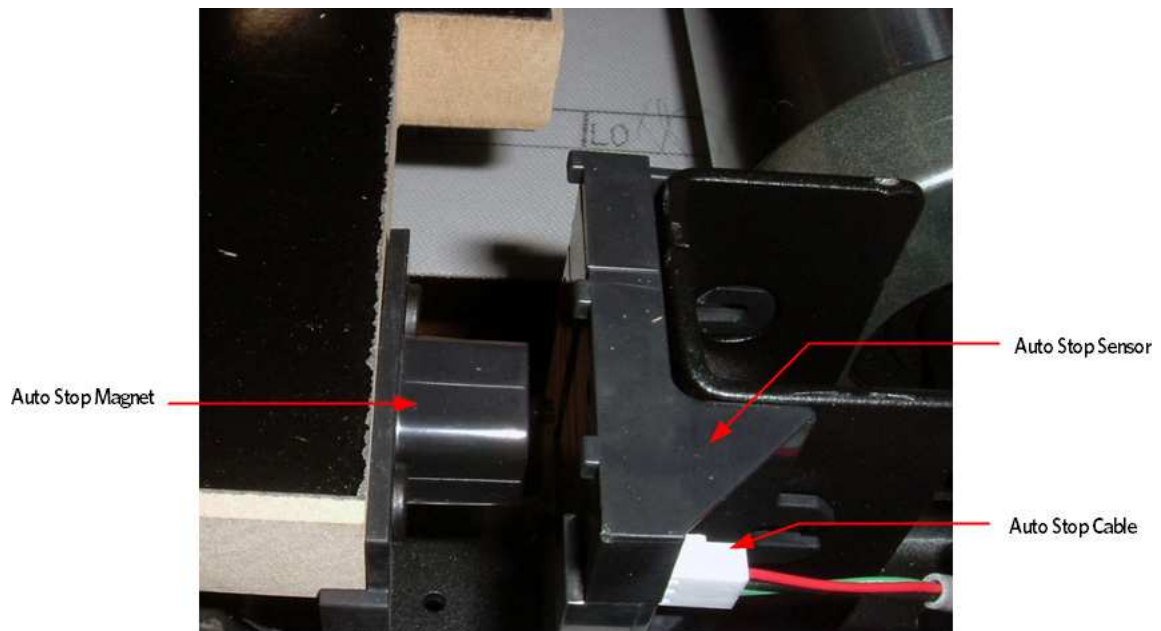

11. Slide the running deck back into position over the running deck pivot bracket. Align the bottom plate and pivot bracket holes with the running deck bolt holes. Replace the plates and the running deck mounting bolts removed in step 7. Only hand tighten the bolts at this time.
12. Hand tighten the bolts and washers back onto the deck securing it to the frame ensuring the bottom retaining plates are between the deck and the pivots. Verify the spacing on all four corners that they are the same..
13. Check the alignment of the magnet and the auto stop assembly. The magnet and the auto stop assembly each have an alignment mark on the top of their housings. The magnet mark and the auto stop mark should align and the gap should be approximately 3/16 of an inch between the housings. A 3/16 allen wrench can be used as a feeler gauge to set the correct gap. If the gap or alignment are off adjust the running deck until the magnet and auto housing are properly aligned.

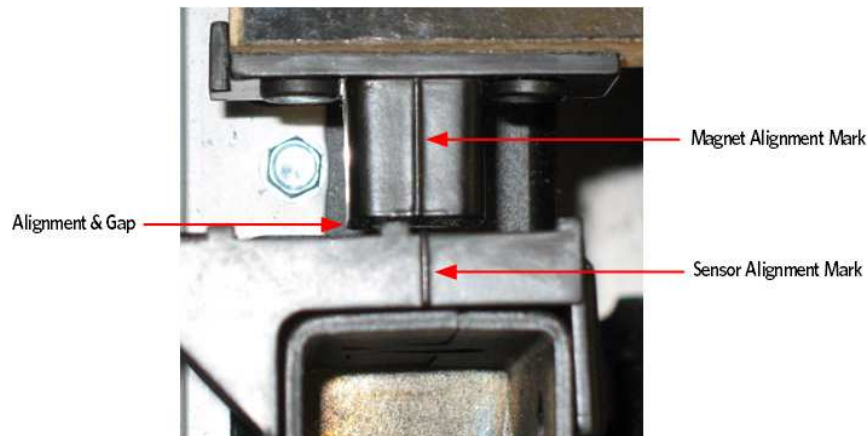

14. Tighten the bolts so the deck is secure. Torque the bolts to 150 inch pounds.
15. Make sure the running belt is in the center of the deck with the same amount of space on each corner of the deck.
16. Start tightening the bolts on the drive roller. The left side will get tighten flush with the front of the bracket. Tighten the right side bolt until it reaches the measurement previously noted in step 7. The drive roller should now be square with the front frame cross beam.
17. Rotate the drive motor flywheel to walk the drive belt onto the drive roller pulley. Be sure the belt is fully onto both pulleys and correctly aligned. A drive belt tension gauge should read 100-120 pounds. The drive belt de-tension after use. A range of 80-90 pounds after the belt has been installed for a while is acceptable.
18. Move the running belt so that the seam is underneath the treadmill. Then place the two running belt tension gauges on each side of the running belt parallel from each other. One side of the gauge is fixed while the other slides side to side. Place the movable side in the middle of its travel and adjust the dial pointer exactly on number 3.

NOTE: Using the number 3 is a reference point only. When the movable side is in the center of travel on the gauge it allows room for increments or decrements.



19. Move the running belt carefully so that you can see the dials easily. Tighten the take up roller mounting bolts alternately in order to tighten both ends evenly. Tighten until the gauges read .55%, which are five and 1/2 lines past the number 3.
20. Remove both gauges from the running belt.

Running Belt Tracking Adjustment



21. Start the treadmill and operate at 1 mph. Observe the running belt and place a marker on one side. If the belt starts to drift toward the right, slowly turn the right side take up roller mounting bolt clockwise until the drifting stops. If the belt starts to drift toward the left, slowly turn the right side take up roller mounting bolt counterclockwise until the drifting stops. The adjustments should only be done in 1/4 turn increments. NOTE: ONLY use the right side take up roller mounting bolt to adjust tracking.
22. Increase the speed to 3 mph for a minute, then 6 mph, 9 mph and finally 12 mph. Making any small adjustments as needed.
23. Set the treadmill speed to 3 mph for a couple of minutes walking on the running belt. Verify that the belt has not moved. Adjust the right side take up roller mounting bolt if needed to make final adjustments.

24. If applicable, replace the finger guard.
25. Replace both running deck trim strips and the end caps and motor cover.

Wiring Diagram 7.1 — C966-120 Vac

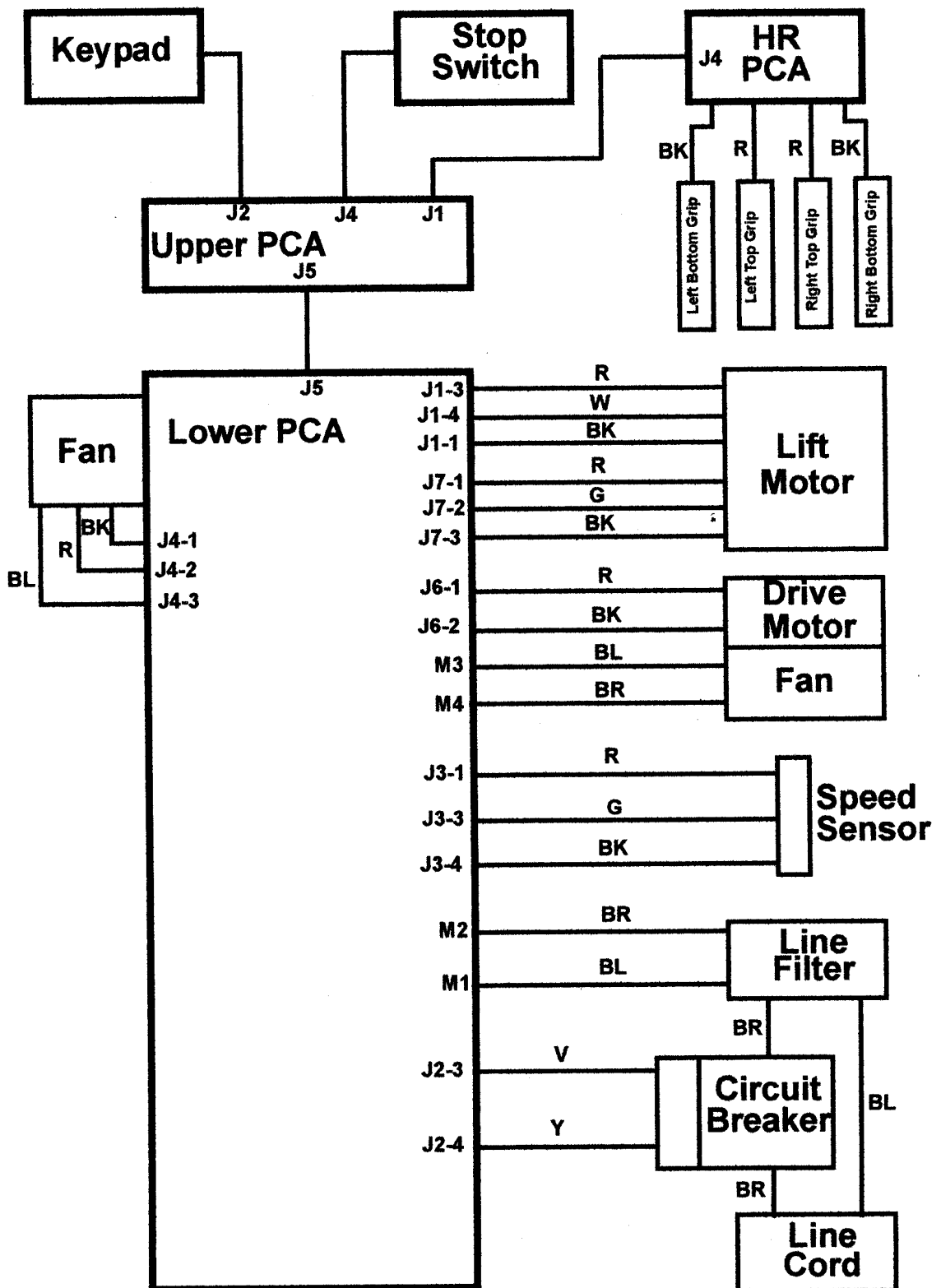

Wiring Diagram 7.2 — C966-240 Vac

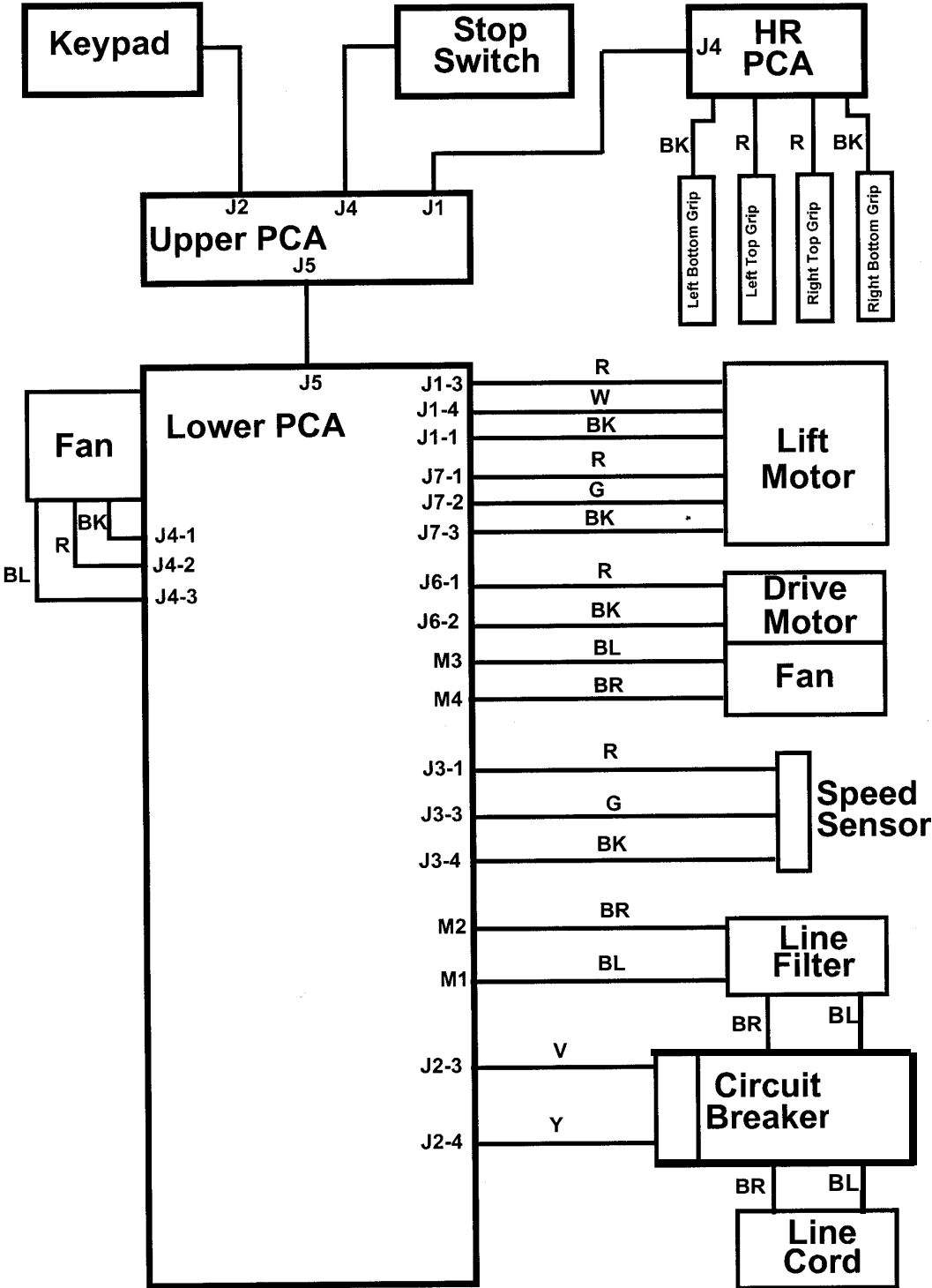

Block Diagram 7.3 — C966 120 Vac



C966-120 PWM Treadmill

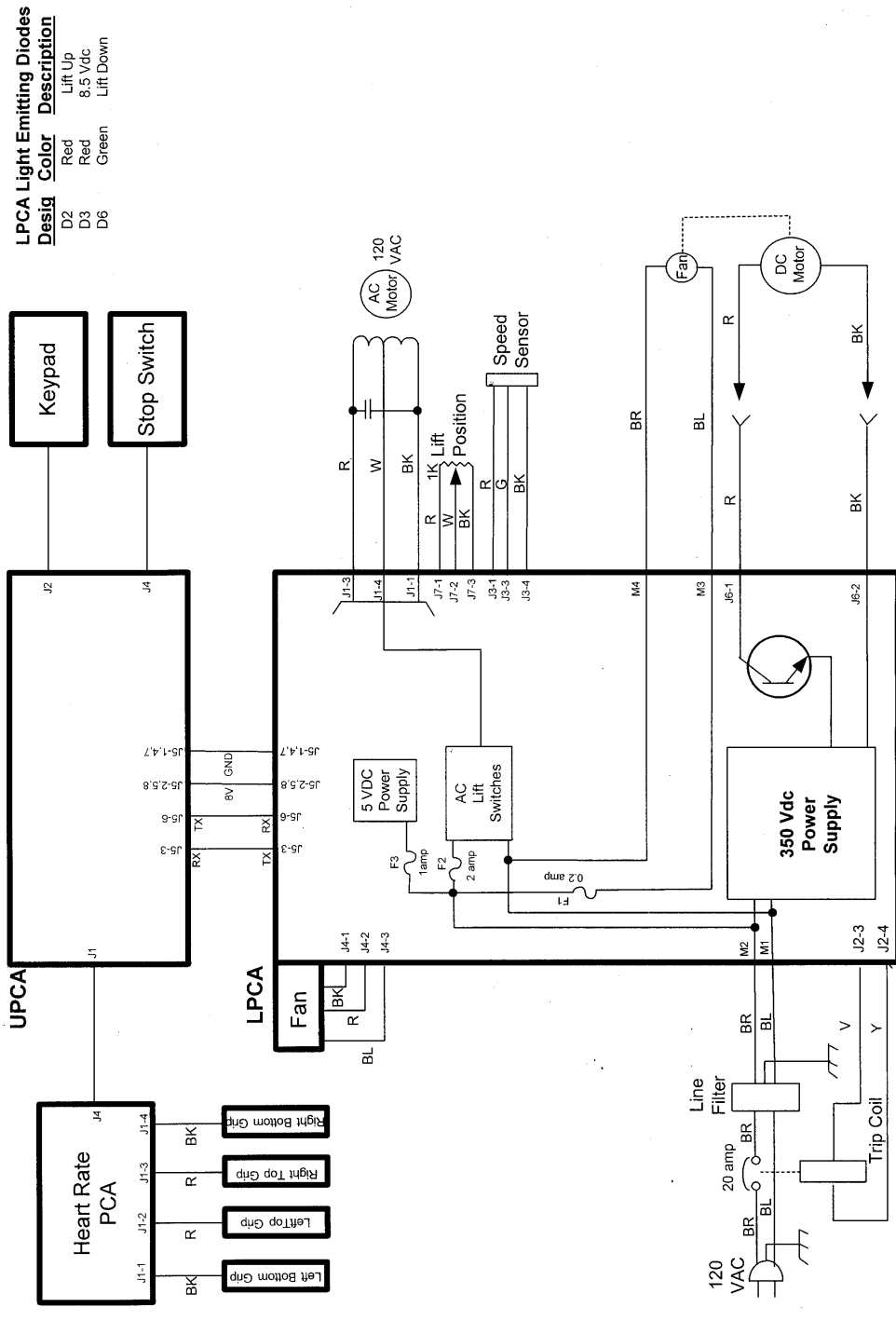

LPCA Light Emitting Diodes

Desig	Color	Description
D2	Red	Lift Up
D3	Red	8.5 Vdc
D6	Green	Lift Down

Block Diagram 7.4 — C966 240 Vac



C966-240 PWM Treadmill

LPCA Light Emitting Diodes

Design	Color	Description
D2	Red	Lift Up
D3	Red	8.5 Vdc
D6	Green	Lift Down

