

9.31, 9.33, 9.35 Treadmill

Warning: This service manual is for use by Precor trained service providers only. If you are not a Precor Trained Servicer, you must not attempt to service any Precor Product; Call your dealer for service.

This document contains information required to perform the majority of troubleshooting, and replacement procedures required to repair and maintain this product.

This document contains general product information, software diagnostic procedures (when available), preventative maintenance procedures, inspection and adjustment procedures, troubleshooting procedures, replacement procedures and electrical block and wiring diagrams.

To move directly to a procedure, click the appropriate procedure in the bookmark section to the left of this page. You may “drag” the separator bar between this page and the bookmark section to change the size of the page being viewed.

Section One - Things you Should Know

About This Appendix

Section One, Things You Should Know. This section includes technical specifications. Read this section, as well as the 9.33 or 9.35 Treadmill Owner's Manual, before you perform the maintenance procedures in this manual.

Section Two, Software Features. Precor treadmills are programmed with several diagnostic and setup features. This section contains the procedures you need to access the diagnostic features on this treadmill.

Section Three, Checking Treadmill Operation. This section provides you with a quick way of checking treadmill operation. Check treadmill operation at the end of a maintenance procedure and when it is necessary to ensure that the treadmill is operating properly.

Section Four, Inspection and Adjustment Procedures. Perform inspection procedures when a trouble symptom points to a particular problem and after removing and replacing major components. Many maintenance problems can be fixed by adjusting various treadmill components. This section also provides you with the step-by-step procedures required to make these adjustments.

Section Five, Troubleshooting Procedures. The diagnostic and troubleshooting procedures contained in this section should be performed when it is necessary to isolate a problem to a particular component.

Section Six, Replacement Procedures. When a treadmill component must be replaced, go to this section and follow the step-by-step procedures required to remove and replace the component.

Section Seven, Technical Diagrams and Parts Lists. This section includes wiring diagrams, and block diagrams for the 9.33 and 9.35 Treadmill.

General Information

For the latest exploded view diagram, part number and part pricing information, visit the Precor dealer website at "www.precor.com/connection".

Procedure 2.1 - Accessing the Hardware Validation Program

The treadmill's diagnostic program consists of the following modes:

- Display Test
- Keyboard Test
- Heart Rate Test
- Machine Test

Procedure

1. Plug the power cord into the wall outlet, then turn on the treadmill with the circuit breaker.
2. Refer to diagram 2.1 below and press keys **RESET,5,1,7,6,5,7,6,1**, sequentially. Use the numeric keypad to enter the number sequence. The **ARROW** keys will step you through the test modes listed above, allowing you to skip tests or perform only specific tests.
3. **DISPLAY TEST.**
4. Press the **OK** key to enter the display test. Press the **OK** or **ENTER** key several times to step through all of the LED's on the display. Ensure that all of the LED's illuminate. Press and hold the **OK** or **ENTER** key to exit the display test.

Diagram 2.1 - 9.33 Display



5. KEYBOARD TEST.

6. The keyboard test will place a dot on the display for each key on the display, including the numeric keypad. Pressing a key will cause the dot associated with the key to go out. Test all of the keys in this manner. Tug on the safety key lanyard, to ensure that the **STOP** key is activated.
7. Press and hold the **OK** or **ENTER** key to exit the keyboard test.

8. HEART RATE TEST.

9. The heart rate test will display the heart rate being received during this test from the hand held grips, chest strap transmitter or test transmitter.
10. The display will toggle between unfiltered and filtered heart rate readings. They will be prefixed "U" for unfiltered, "F" for filtered. When a heart rate signal is being accepted the "heart" will blink and the heart rate will be displayed in the heart rate window and the main window. Test the heart rate in both the hand held and wireless (chest strap or test transmitter) modes.
11. Press the **OK** or **ENTER** key to exit the heart rate test.

12. MACHINE TEST.

13. There are two test modes in the **MACHINE TEST**, they are **BELT SPEED** and **INCLINE**. Use the **ARROW** keys to select the desired test.
14. **BELT SPEED**
15. Press the **OK** or **ENTER** key. **POWERBITS** will be momentarily displayed then the powerbit number will be displayed. The power bit level can be checked by starting the running belt.
16. Press the **OK** key to exit the belt speed test.
17. **INCLINE**
18. Press the **OK** or **ENTER** key. **A/D** will be momentarily displayed then the analog to digital lift position number will be displayed. The analog to digital lift position number represents the incline's physical position. The A/D number is used to calibrate the incline. The incline must be calibrated when a new lift motor is installed.
19. Press the **RESET** to exit the **MACHINE TEST**.

Procedure 2.2 - Accessing the Information Display Program

The information display will access the following data;

- Odometer
- Hour Meter
- U Boot SW
- U Base SW
- Lower SW
- Metrics Board SW
- Usage log
- Error log

Procedure

1. Plug the power cord into the wall outlet, then turn on the treadmill with the circuit breaker.
2. Refer to diagram 2.1 above and press keys **RESET,6,5** sequentially. Use the numeric keypad to enter the number sequence. The **ARROW** keys will step you through the display modes listed above, allowing you to skip displays or view only specific displays.
3. The display will momentarily read, **DIAGS - INFORMATION DISPLAY.**
4. **ODOMETER**
5. Press the **OK** or **ENTER** key. The treadmill's odometer will be displayed as **1234567 MILES** or **1234567 KM.**

Note: The odometer data is stored in non-volatile memory on the upper PCA. If the upper PCA is replaced the odometer data will be lost.

6. Press the **OK** or **ENTER** key to exit the odometer display.
7. **HOURLY METER.**
8. Press the **OK** or **ENTER** key. The operating time of the unit will be displayed as **12345 HOURS.** The operating time is defined as total amount of time that the unit has operated in program modes with the drive motor running. The hour meter is also used to provide the "time stamp" for the error code log.
9. Press the **OK** or **ENTER** key to exit the hour meter display.
10. **U BOOT SW**
11. Press the **OK** or **ENTER** key. The U Boot SW part number will be displayed. The U Boot SW is the software internally used to upload upper PCA operating system software (U Base SW).

12. Press the **OK** or **ENTER** key to exit the U Boot SW display
13. **U BASE SW**
14. Press the **OK** or **ENTER** key. The U Base SW part number will be displayed. The U Base SW is the upper PCA operating system software.
15. Press the **OK** or **ENTER** key to exit the U Base SW display.
16. **LOWER SW**
17. Press the **OK** or **ENTER** key. The Lower SW part number will be displayed. The Lower SW is the lower PCA operating system software.
18. Press the **OK** or **ENTER** key to exit the Lower SW display.
19. **METRICS BOARD SW**
20. Press the **OK** or **ENTER** key. The metrics board software part number will be displayed.
21. Press the **OK** or **ENTER** key to exit the metrics board SW display.
22. **USAGE LOG**
23. Press the **OK** or **ENTER** key. The usage for each program can be displayed. The **ARROW** keys will allow to scroll through the list of programs. For example the manual program usage will be displayed as **MANUAL USED X TIMES TOTAL X MINUTES.**
24. Press the **OK** or **ENTER** key to exit the usage log display.
25. **ERROR LOG**
26. Press the **OK** or **ENTER** key.
27. The error log will store up to 10 error conditions. The errors are logged with the most recent error in position one. When a new error condition occurs, each existing error is pushed down one position in log. If there was an error in position 10 when a new error was logged, the error that was in position 10 will be lost.
28. Each error in the log will show the odometer reading (in miles) and the time (hour meter) and motor current reading when the error occurred. The errors are displayed as;
1 ER20 XXXXX MI XXX HRS. XX.X AMPS
29. The **ARROW** keys will allow you to scroll through the log.
30. When the **QUICK START** key is held for 2 seconds the message **HOLD TO CLEAR ERRORS** will be displayed. If the **QUICK START** key is held for an additional 2 seconds, the log will be cleared. The message **NO ERRORS** will be displayed and all error are erased from the log.

31. Press the **RESET** key to exit the information display.
32. Note: the error log can also be entered at any time by pressing and holding the **RESET** key for four seconds.

Procedure 2.3 - Accessing the User Parameter Program

This procedure allows you to change the following settings:

- Select Units (9.31, 9.33)
- Set Max Pause Time
- Set Cool Down Time
- Set Speed Limit

Procedure

1. Plug the power cord into the wall outlet, then turn on the treadmill with the circuit breaker.
2. Refer to diagram 2.1 above and press keys **RESET,5,6,7,1** sequentially. Use the numeric keypad to enter the number sequence. The **ARROW** keys will step you through the display modes listed above, allowing you to skip displays or view only specific displays.
3. The display will momentarily display **DIAGS - SET PARAMETERS**
4. **SELECT UNITS** (9.31, 9.33)
5. The currently selected measurement unit will then be displayed.
6. Use the **ARROW** keys to toggle between **U.S.** and **METRIC**.
7. Press the **ENTER** key to select the currently displayed measurement unit.

Note: To change the measurements units on a 9.35, Press the **METRICS** key, select the measurement unit with the **ARROW** keys and save the selection with the **OK key**.

8. **SET MAX PAUSE TIME**
9. Press the **OK** or **ENTER** key.
10. Use the **ARROW** keys to set the maximum pause time between 1 and 10 minutes.
11. Press the **ENTER** key to select the currently displayed pause time.
12. **SET COOL DOWN TIME**
13. Press the **OK** or **ENTER** key.
14. Use the **ARROW** keys to set the COOL DOWN time between 1 and 5 minutes.
15. Press the **ENTER** key to select the currently cool down time.

16. **SET SPEED LIMIT**

17. Press the **OK** or **ENTER** key.
18. Use the **ARROW** keys to set the maximum speed between 1 and 12 MPH.
19. Press the **ENTER** key to select the currently displayed speed limit.
20. Press the **RESET** key to exit the set club parameters display.

Procedure 2.4 - Documenting Software Problems

When a problem is found with the software in the upper or lower PCA, record the information listed below.

When a problem occurs, record the following information:

- Model and serial number
- Software version number

- Program number running when the problem occurred
- A description of:
 - a. What happened or failed to happen.
 - b. The action taken by the user just before the problem occurred.
 - c. Problem-related information (such as how far into the program the problem occurred, the work level being used when the problem occurred, etc.).

- The frequency of occurrence.

Section Three - Checking Treadmill Operation

This section provides you with a quick method of checking treadmill operation. Check treadmill operation at the end of a maintenance procedure and when it is necessary to ensure that the treadmill is operating properly.

Procedure

1. Plug the power cord into the wall outlet, then turn on the treadmill with the circuit breaker.
2. Place the treadmill in Manual Mode. Adjust the speed of the running belt to 2–3 m.p.h. Operate the treadmill for at least 5 minutes.
 - a. Concentrate on the feel of the running belt and the sound of the drive motor and rollers. Be on the alert for unusual noises, smells, or vibrations.
 - b. Enter the Hardware Validation Program and log the power bits under loaded and unloaded conditions.
 - c. Observe the LED's on the electronic console. Make sure that each LED lights as the information corresponding to that LED is displayed on the electronic console.
3. Press the **STOP** key. When the treadmill comes to a stop, view the electronic console as the treadmill scans time, speed, distance and percent of lift.
4. Press the **INCLINE ▲** key while viewing the electronic console. Confirm that the running bed inclines and the incline display increments to 15% as the **INCLINE ▲** key is pressed.
5. Press the **INCLINE ▼** key while viewing the electronic console. Confirm that the running bed returns to a level position and the incline display decrements to 0% (9.31, 9.33) or -2% (9.35) as the **INCLINE ▼** key is pressed.
6. Turn off the treadmill with the circuit breaker, then unplug the treadmill from the wall outlet.

Procedure 4.1 - Calibrating the Lift Motor

1. Set the treadmill circuit breaker in the "off" position and unplug the line cord from the wall outlet.
2. Remove the motor cover.
3. Place the treadmill on it's right side. Remove hitch and clevis pins that secure the lift tube to the lift platform.

Diagram 4.1 - Lift Motor Mounting

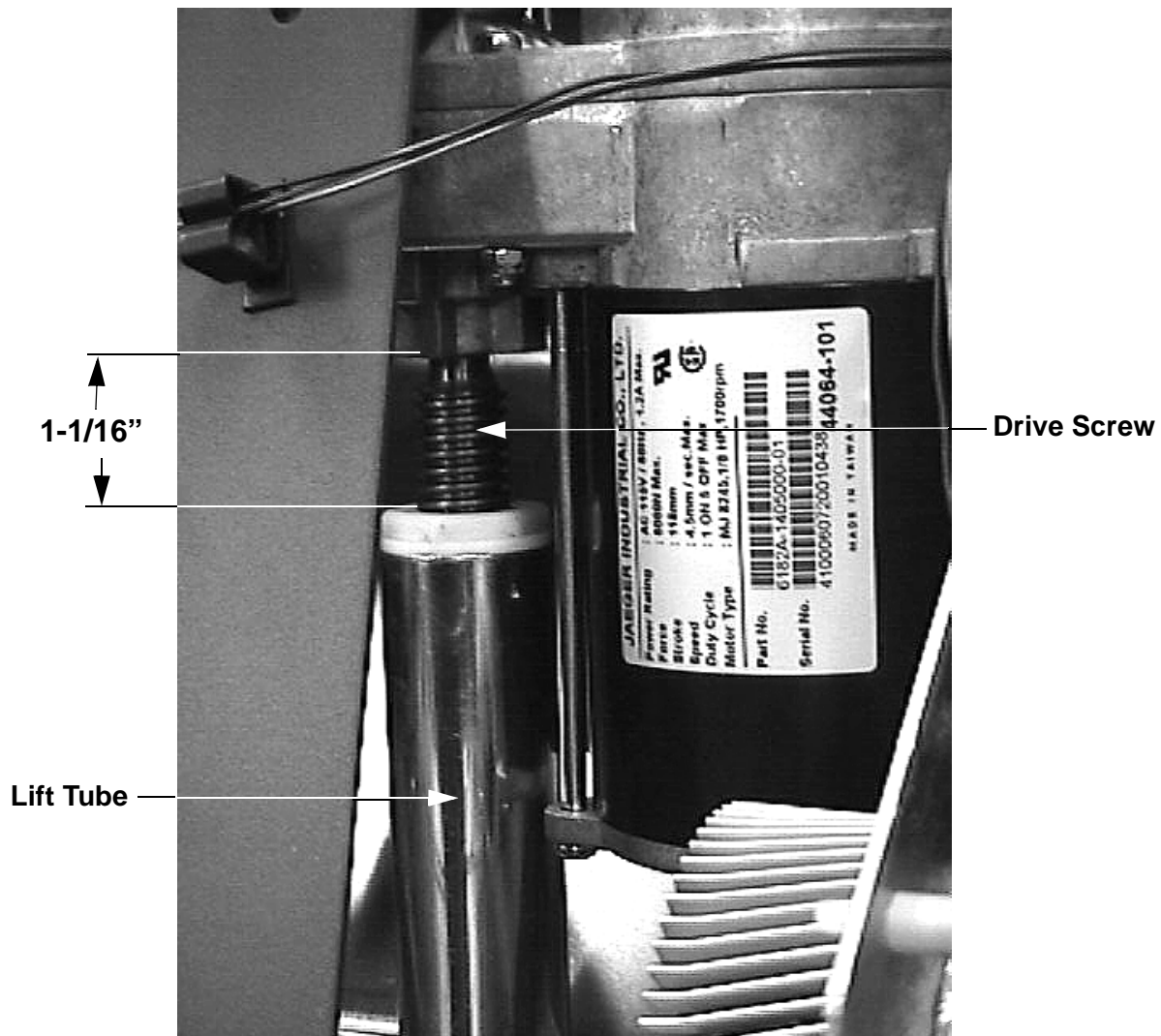

4. Plug the power cord into the wall outlet, set the treadmill circuit breaker in the “on” position.
5. Press keys **RESET, 5,1,7,6,5,7,6,1**, sequentially to enter the diagnostics routine. Refer to Procedure 2.1 and advance to the lift test. When the lift calibration number is displayed on the console, use the **INCLINE ▲** or **INCLINE ▼** key to set the lift calibration number to 38.

CAUTION

While running the lift motor in the diagnostics mode it is possible to operate the lift motor beyond its normal range of motion. When you perform the next step, care must be taken not to jam the lift tube against the motor frame.

6. Press the **RESET** key to exit the diagnostics mode.
7. Set the treadmill circuit breaker in the “off” position, unplug the line cord from the wall outlet.
8. Rotate the lift tube clockwise, by hand, as far as possible. Then rotate the lift tube counter-clockwise until the distance from the top of the lift tube to the lift motor is 1-1/16 inch. See Diagram 4.1. While rotating the lift tube, be sure the lift motor drive screw does not rotate. If the drive screw is rotated, return to step 4 and repeat steps 4 through 7.
9. Replace the clevis and hitch pins removed in step 3. Return the treadmill to an upright position.
10. Plug the line cord into the wall outlet, set the treadmill circuit breaker in the “on” position.
11. Check the calibration of the lift system by performing the following steps:
 - a Press the **QUICK START** key. Press the **INCLINE ▲** key until the console displays 15% incline.
 - b Press the **INCLINE ▼** key to return to 0% (9.31, 9.33) or -2% (9.35) incline.
12. Re-install the motor cover.

Procedure 4.2 - Adjusting Drive Belt Tension

1. Set the treadmill circuit breaker in the “off” position and unplug the line cord from the wall outlet.
2. Remove the motor cover.
3. Place the drive belt tension gauge on the drive belt as shown in Diagram 4.2.

Diagram 4.2 - Drive Belt Tension Gauge



4. The gauge should read approximately 75 inch/pounds. The drive belt tension is acceptable if it is in the range of 60 to 90 inch-pounds.
5. If the drive belt tension is less than 60 or greater than 90 inch/pounds, slightly loosen the four drive motor mounting bolts. The drive motor mounts on slotted holes allowing the drive motor to be move forward or rearward. Move the drive motor forward or rearwards, as required, until the belt gauge reads approximately 75 inch/pounds and tighten the four drive motor mounting bolts. See Diagram 4.3. Momentarily remove the drive belt tension gauge from the drive belt. Replace the drive belt tension gauge on the drive belt and re-adjust the drive belt tension, if necessary. Torque the four drive motor mounting bolts to 180 inch pounds.

6. Re-install the motor cover.

Diagram 4.3 - Drive Belt Adjustment

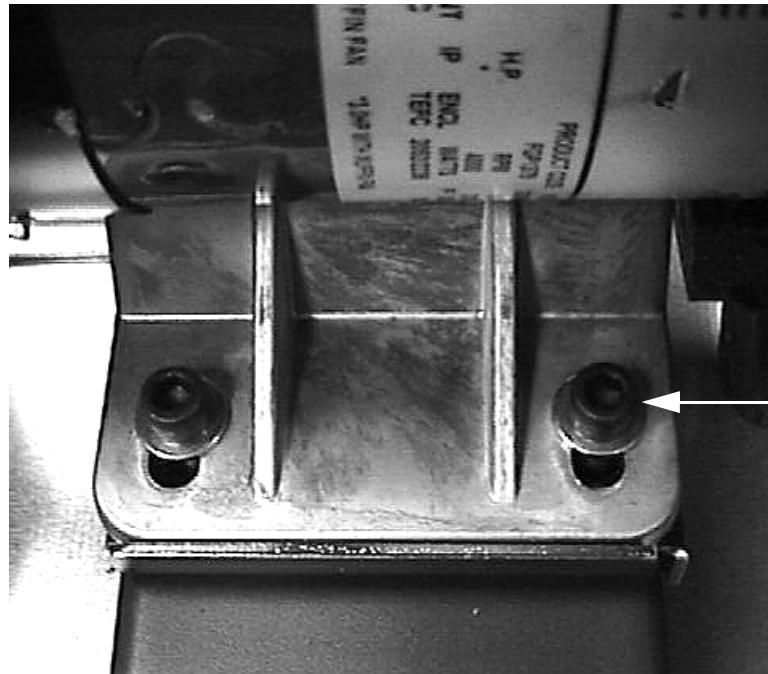

**Drive Motor
Mounting Bolt**

7. Plug the line cord into the wall outlet and set the treadmill circuit breaker in the “on” position.
8. Check treadmill operation per Section 3.

Procedure 4.3 - Treadmill Belt Cleaning

Procedure:

1. First, check for proper operation of the safety stop key. Stand to one side of the treadmill. Insure that the stop key tether is hanging straight down from the stop key and is not wrapped around the handle bars. Push the "Quick Start" button and wait for the display to count down and for the running belt to begin moving. Once the running belt is moving pull the safety stop key tether. **See the illustration below.**

CAUTION: If the running belt does not stop, turn off the power using the ON/OFF switch at the front of the treadmill and unplug the power cord. The treadmill must remain out of service until the stop switch is repaired.
If the running belt stops, continue with the cleaning procedure.

2. A clean, dry towel approximately 36 inches or 1 meter in length is required. Fold the towel in half lengthwise, lift the running belt up and insert the towel beneath the belt so that an end of towel extends on to each deck trim. **See the illustration below.**



3. Stand to one side of the treadmill, push the "Quick Start" button, grasp the towel as illustrated in the illustration above. **Note:** You will have 3 seconds to firmly grasp your hands on the towel before the treadmill running belt begins to move. Allow the treadmill to run for about one minute while holding the towel firmly in place.

CAUTION: If the towel becomes loose it may be pulled into the treadmill's rollers. Pull the safety key tether to stop the treadmill and retrieve the towel, no damage should occur. Start the procedure over again.
See the illustration below.

4. Keep one hand firmly grasped on the towel, use your other hand to pull on the safety stop key tether to stop the treadmill running belt. **See the illustration below.**

5. Turn the power off. Place your hands on the towel and push it up and down the length of the running deck several times to clean the deck.
6. Remove the towel.

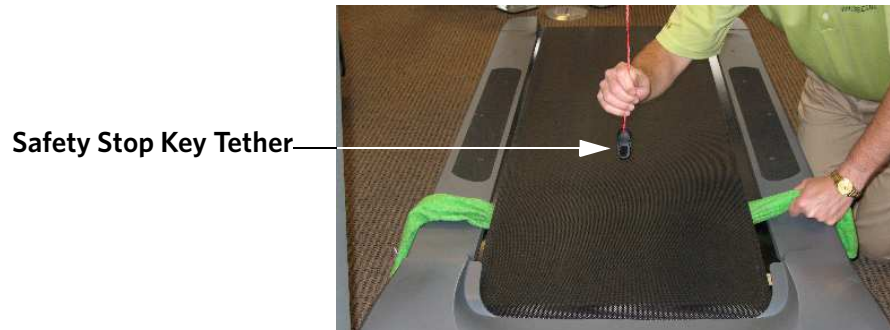

It is recommended that this procedure be performed frequently to extend the life of the running belt and running deck.

Procedure 5.1 - Troubleshooting the Keypad and Upper PCA

If the function keys on the electronic console are unresponsive, the problem may be either the upper PCA or keypad.

Procedure

1. Set the circuit breaker in the “on” position.

WARNING

Before continuing with this procedure, review the Warning and Caution statements listed in Section One of the Residential Treadmill Service Manual.

2. If the treadmill powers up and functions normally until a particular key(s) is pressed, skip to step 8.
3. If a **Stuck Key** message is immediately displayed when the treadmill is powered up, continue with the next step.
4. This condition may be caused by either the keypad or upper PCA. Set the circuit breaker in the “off” position. Remove the two screws that retain the reading rack and remove the reading rack. Remove the eight screws that retain the display face, two are under the reading rack. See Diagram 5.1.

Diagram 5.1 - Display Console (Rear View)



- Carefully, lift the display housing front panel off of the display housing backing plate. Disconnect both keypad cables from the upper PCA. See Diagram 5.2. **Note:** If the **STOP** switch cable is disconnected or the **STOP** switch is activated or defective the message **STOP SWITCH** will be displayed.

Diagram 5.2 - 9.33 Upper PCA & Keypad

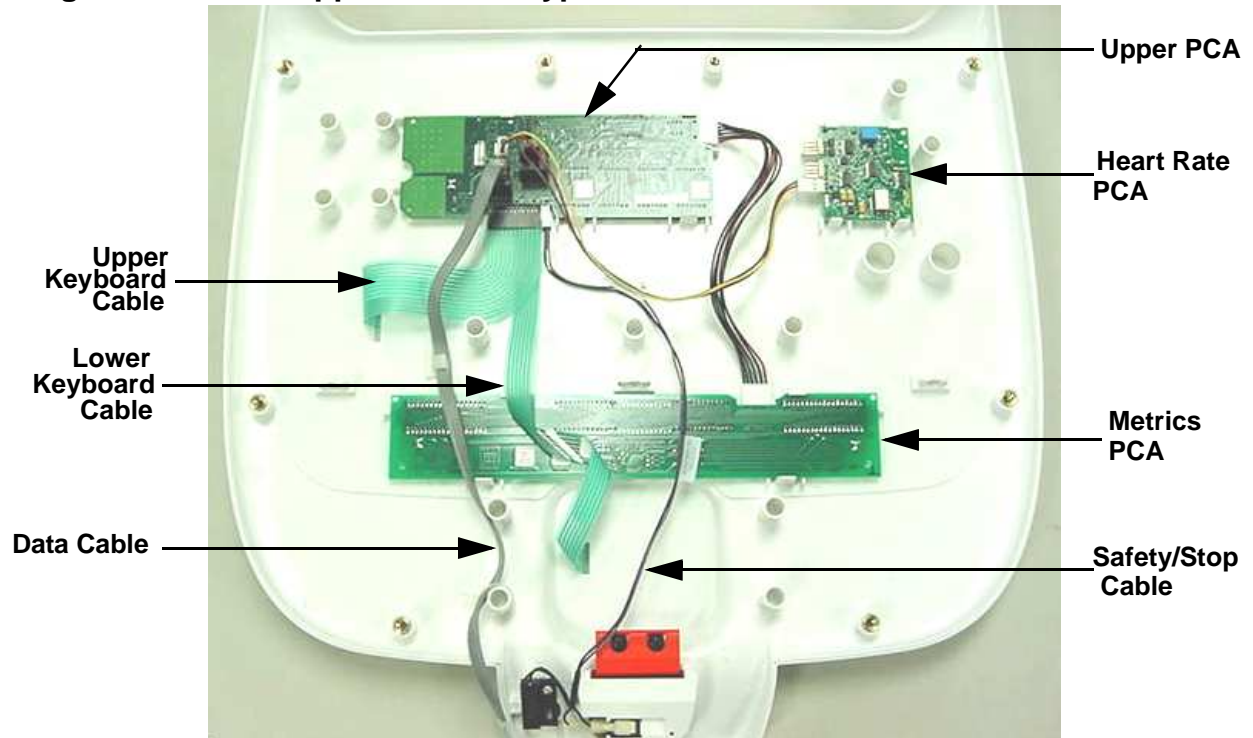

- If the **STUCK KEY** message is still displayed, replace the upper PCA. If the **STUCK KEY** message is no longer displayed, replace the display panel.
- If you have performed all of the procedures above and have been unable to correct the problem, call Precor customer service.
- Test the keypad per Procedure 2.1.
- Access the diagnostics program per procedure 2.1. If the key(s) necessary to access the diagnostic program is not functioning, skip to step 11.
- If all of the keys test good, the problem may be user error or a key function that is normally disabled during a particular user program.

11. If one or more keys do not function correctly, either the keypad (display housing) or upper PCA could be defective. Replace the display and repeat step 9. If the display housing did not correct the problem, re-install the original display housing and replace the upper PCA.
12. If you have performed all of the procedures above and have been unable to correct the problem, call Precor customer service.

Procedure 5.2 - Troubleshooting the Lift System

Lift System Description:

The lift system on these units consists of an A.C. line voltage driven lift motor (120 Vac), and an internal 1 K Ω potentiometer for lift position identification. The lift motor contains two motor windings, one to operate the motor in an “upward” direction and the other to operate the motor in a “downward” direction. As the lift motor is operated, the motor also rotates the potentiometer via an internal gear system. Therefore, the position of the lift system can be determined by monitoring the value of the internal potentiometer. The lift motor is initially set at a known starting position (calibration, See Procedure 4.1), subsequent motor movement is tracked via the potentiometer resistance reading. **Note:** If the potentiometer circuit is shorted the diagnostics A/D number will be 0, if the potentiometer circuit is open the diagnostics A/D number will be 255.

Note:

All resistance measurements must be performed with power removed from the treadmill. Performing resistance measurements with voltage applied may damage your ohmmeter.

Procedure

1. If the lift motor operates but creates a lift error (error 40 or 42) go to step 16. If the lift motor will not move continue with step 2.
2. Set the treadmill's circuit breaker in the “off” position and remove the A.C. line cord from the A.C. outlet. Remove the treadmill's motor cover.
3. Remove the F1 (Lift) fuse from the lower PCA. Using an ohmmeter, check the resistance of the F1 fuse. See Diagram 5.2. The fuse should measure approximately 0.1 Ω or less. If the fuse is open or high resistance, replace the fuse.

Diagram 5.2 - Lower PCA

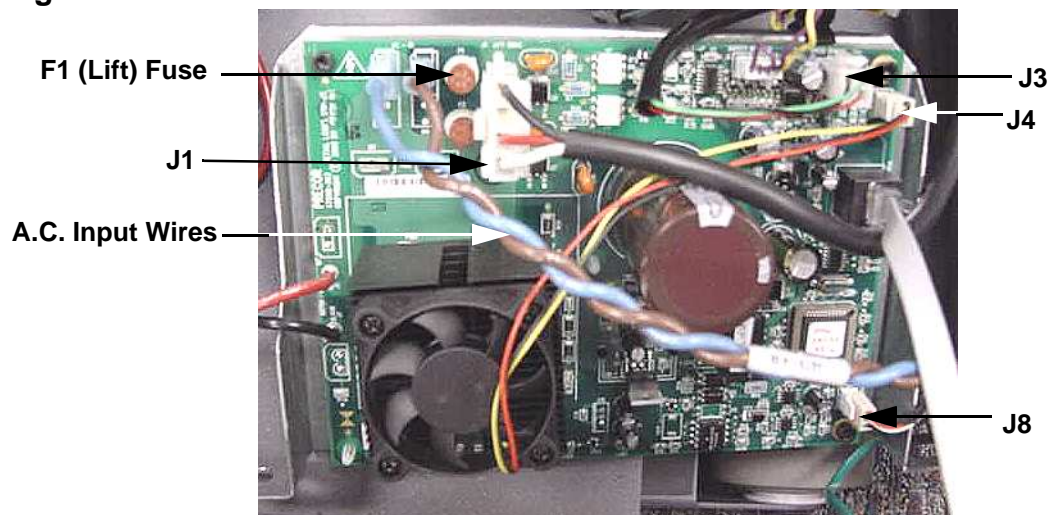

4. Insert the treadmill's A.C. line cord in the A.C. outlet and set the circuit breaker in the "on" position. Set the treadmill in the manual program and press the **LIFT ▲** key. If the lift motor operates normally, test treadmill operation per Section 3. If the lift motor still does not operate, retest the lift fuse per steps 2 & 3. If the fuse is open again, continue with step 13. If the fuse is good continue with step 5.
5. Connect an A.C. voltmeter between terminals 1 & 4 of the J1 connector. See Diagram 5.2. Set the treadmill in the manual program and press the **LIFT ▲** key. The A.C. voltmeter should read A.C. line voltage (120 Vac) and the red **DS1** LED should illuminate. Note that the A.C. line voltage reading will only be present prior to an error condition occurring.
6. If the F1 fuse is good and the **DS1** LED illuminates and the A.C. voltmeter does not read the presence of A.C. line voltage replace the lower logic PCA per Procedure 6.3.
7. If the **DS1** LED does not illuminate and the display indicates that the lift should be moving upward, replace the upper PCA.
8. If the A.C. voltmeter reads the presence of A.C. line voltage and an error 40 is displayed, go to step 10.
9. If the A.C. voltmeter reads the presence of A.C. line voltage and an error 42 is displayed, continue with step 11.
10. Set the treadmill's circuit breaker in the "off" position and remove the A.C. line cord from the A.C. outlet. Remove the lift motor connector from the J1 connector on the lower PCA. Visually inspect the lift motor connector for broken or improperly crimped connections. Using an ohmmeter, read the resistance between terminals 1 & 4 and between terminals 3 & 4. Both readings should be approximately 13.25 Ω . If either reading is open or very high resistance, replace the lift motor per Procedure 6.1.
11. Set the treadmill's circuit breaker in the "off" position and remove the A.C. line cord from the A.C. outlet. Remove the lift motor connector from the J8 connector on the lower PCA. Visually inspect the lift motor connector for broken or improperly crimped connections. Using an ohmmeter, measure between terminals 1 & 3, 1 & 2 and 2 & 3 of the lift motor connector. Terminals 1 and 3 should read approximately 1 K Ω . The sum of the two readings between terminals 2 & 3 and 1 & 2 should total approximately 1 K Ω . If either reading is open or very high resistance, replace the lift motor per Procedure 6.1.
12. If you have performed all of the procedures above and have been unable to correct the problem, call Precor customer service.
13. Set the treadmill's circuit breaker in the "off" position and remove the A.C. line cord from the A.C. outlet. Remove the lift motor connector from the J1 connector on the lower PCA. Visually inspect the lift motor connector for broken, frayed or improperly crimped connections. Using an ohmmeter, read the resistance between terminals 1 & 4, 3 & 4 and 1 & 3. The readings should be approximately 13.25 Ω , 13.25 Ω and 26.5 Ω , respectively. If the reading is significantly low, replace the lift motor per Procedure 6.1.

14. If the resistance readings in step 13 are normal, replace the lower logic PCA per Procedure 6.3.
15. If you have performed all of the procedures above and have been unable to correct the problem, call Precor customer service.
16. Set the treadmill's circuit breaker in the "off" position and remove the A.C. line cord from the A.C. outlet. Remove the lift motor connector from the J8 connector on the lower logic PCA. Visually inspect the lift motor connector for broken or improperly crimped connections. Using an ohmmeter, measure between terminals 1 & 3, 1 & 2 and 2 & 3 of the lift motor connector. Terminals 1 and 3 should read approximately 1 K Ω . The sum of the two readings between terminals 2 & 3 and 1 & 2 should total approximately 1 K Ω . If either reading is open or very high resistance, replace the lift motor per Procedure 6.1.
17. If the resistance measurements in step 16 are normal, the problem may be either the lower logic PCA or the upper PCA. Replace the lower logic PCA. If the problem persists, reinstall the original lower logic PCA and replace the upper PCA.
18. If you have performed all of the procedures above and have been unable to correct the problem, call Precor customer service.

Procedure 5.3 - Troubleshooting the Speed Sensor

Note:

The speed sensor is an optical sensor that emits a pulse when an interrupter lobe passes between its transmitter and receiver. The speed control circuit processes the pulse train emitted by the speed sensor. The speed sensor signal is a real time representation of the operating speed of the treadmill. The speed control circuit compares the real time speed (speed sensor output) with the speed that it expects the treadmill to be operating at and acts accordingly to control treadmill speed or initiate an error code sequence, if necessary. Typically, if a problem exists with the speed sensor the drive motor will operate (perhaps only briefly) before a speed related error occurs (errors 20-26).

1. Remove the treadmill's motor cover and set the treadmill's circuit breaker in the "on" position. Using a DC voltmeter, measure the voltage between terminal 3 of J3 and terminal 4 of J3 on the lower PCA. Slowly, rotate the drive motor flywheel. The voltage should read approximately 0.25 Vdc when a flywheel lobe is between the speed sensor "legs" and approximately 5 Vdc when a flywheel lobe is not between the speed sensor "legs".

Diagram 5.3 - Speed Sensor Mounting

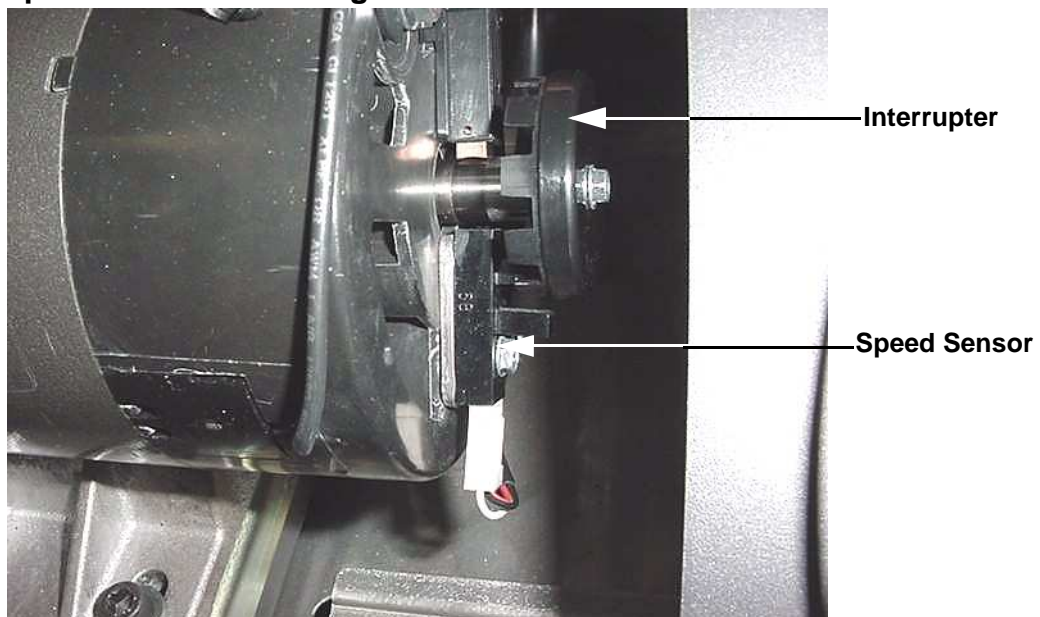

2. If the voltages in step 1 are correct, skip to step 5. If the voltage in step 1 is 0 Vdc or significantly low when a flywheel lobe is between the speed sensor "legs", continue with step 3.

3. Measure the voltage between terminal 1 of J3 and terminal 4 of J3 on the lower PCA, see Diagram 5.2. The voltage should read approximately 5 Vdc. If the voltage is missing or significantly low, disconnect the speed sensor plug from the lower PCA. Measure the voltage between pins 1 & 4 of the J3 connector on the lower PCA. If the voltage is approximately 5 Vdc, replace the speed sensor. If the voltage is missing or significantly low, replace the lower logic PCA.
4. If at this point the speed sensor output is good, but a speed error occurs, replace the upper PCA.
5. If you have performed all of the above procedures and have been unable to correct the problem, call Precor Customer Support.

Procedure 5.4 - Troubleshooting the External A.C. Power Source

It is extremely important that any Precor treadmill be connected to and operated on a dedicated 20 amp A.C. circuit. A 20 amp dedicated circuit is defined as: a circuit fed by a 20 amp circuit breaker that feeds a single load. A treadmill operating from a non-dedicated circuit or a circuit breaker of less than 20 amps capacity will not have the necessary power available to operate normally under higher load conditions. The lack of available power can cause any number of symptoms ranging from numerous intermittent (seemingly inexplicable) error conditions, poor speed control, or tripping the house circuit breaker.

If any of the above symptoms exist the external A.C. circuit must be checked and confirmed to be a 20 amp dedicated circuit **before** troubleshooting the treadmill.

In addition the A.C. voltage must be checked. Nominal A.C. operating voltage on 120 Vac circuits is 105 Vac to 120 Vac. Nominal A.C. operating voltage on 240 Vac circuits is 208 Vac to 240 Vac. For operator safety considerations and to minimize electrostatic discharge conditions the A.C. frame ground continuity must also be verified to be a low resistance connection to the A.C. distribution ground bar.

Important

If the A.C. circuit feeding a treadmill is found to be a non-dedicated circuit or a circuit equipped with a circuit breaker with a capacity of less than 20 amps, the A.C. circuit must be corrected to be a 20 amp dedicated circuit **before** any reliable troubleshooting can be performed on the treadmill. More importantly, a non-dedicated circuit may constitute a safety hazard to the treadmill operator.

120 Vac Systems

120 Vac distribution systems utilize a single pole circuit breaker (hot lead) and a neutral lead connected to a common neutral (ground) bar. The A.C. safety ground (green wire) is connected to a separate ground bar in the distribution system.

The most common problems found are (1) the circuit is fed by a circuit breaker of less than 20 amp capacity, (2) the circuit breaker correctly feeds a single A.C. outlet but the neutral is common between several A.C. outlets and (3) both the hot and neutral leads feed several A.C. outlets. The appropriate correction action or actions (see below) must be followed if any of the above conditions exist. **Corrective actions should only be undertaken by a licensed electrician.**

1. The circuit breaker feeding the treadmill is not a 20 amp circuit breaker.

If the circuit breaker is greater than 20 amps, the circuit breaker should be replaced with a 20 amp circuit breaker. If the circuit breaker is less than 20 amps the circuit breaker must be replaced with a 20 amp circuit breaker and the wiring from the A.C. distribution must be capable of safely handling 20 amps. If the A.C. wiring is under sized, it must be replaced with wire capable of safely handling 20 amps. Please, refer to local electrical codes when determining the appropriate wire size for a 20 amp circuit.

2. The circuit breaker correctly feeds a single A.C. outlet but the neutral is common between several A.C. outlets.

The common neutral lead must be removed from treadmill's A.C. outlet and a new neutral lead from the treadmill's A.C. outlet to the A.C. neutral distribution bar must be added.

3. Both the hot and neutral leads feed several A.C. outlets.

Both the common neutral and hot leads must be removed from treadmill's A.C. outlet and a new neutral lead and hot lead from the treadmill's A.C. outlet to the A.C. neutral distribution bar and circuit breaker must be added.

240 Vac Systems

240 Vac distribution systems utilize a double pole circuit breaker (two hot leads) The A.C. safety ground (green wire) is connected to a ground bar in the distribution system.

The most common problems found are (1) the circuit is fed by a circuit breaker of less than 20 amp capacity and (2) both the hot leads feed several A.C. outlets. The appropriate correction action or actions (see below) must be followed if any of the above conditions exist. **Corrective actions should only be undertaken by a licensed electrician.**

1. The circuit breaker feeding the treadmill is not a 20 amp circuit breaker.

If the circuit breaker is greater than 20 amps, the circuit breaker should be replaced with a 20 amp circuit breaker. If the circuit breaker is less than 20 amps the circuit breaker must be replaced with a 20 amp circuit breaker and the wiring from the A.C. distribution must be capable of safely handling 20 amps. If the A.C. wiring is under sized, it must be replaced with wire capable of safely handling 20 amps. Please, refer to local electrical codes when determining the appropriate wire size for a 20 amp circuit.

2. Both the hot leads feed several A.C. outlets.

Both hot leads must be removed from treadmill's A.C. outlet and two new hot leads from the treadmill's A.C. outlet to the circuit breaker must be added.

A licensed electrician may use the followings hints to determine if an A.C. service is dedicated.

1. If, on a 120 Vac system, the A.C. distribution panel contains more circuit breakers than neutral leads, the system has shared neutral leads and is not dedicated.
2. If an A.C. outlet (120 or 240 Vac) has multiple hot and/or neutral leads, it is not a dedicated.
3. If either of the above conditions exist, the system is not dedicated. However, absence of the above conditions does not necessarily mean that the system is dedicated. If any doubt exists about A.C. systems dedication, point to point tracing of the A.C. wiring may be the only way to prove system dedication.

Procedure 5.5 - Troubleshooting Heart Rate

Circuit Description

The hand held heart rate system is actually a dual system, that is, it can accept a heart rate signal from either the hand held heart rate contacts on the unit's handlebar or from a Polar heart rate chest strap transmitter. The PCA is configured for hand held priority. That is, if both a chest strap and hand heart rate signal are being received, the system will accept the hand held signal and ignore the chest strap signal. If a hand held signal is not being received, the system will accept the chest strap signal.

Note:

There are four typical failure modes for the hand held/chest strap heart rate system. They are: hand held is normal - no chest strap reading; no hand held reading - chest strap normal; no hand held or chest strap reading or constant or intermittent readings when neither hand held or chest strap are in use.

Diagram 6.3 - Hand held/chest strap heart rate PCA

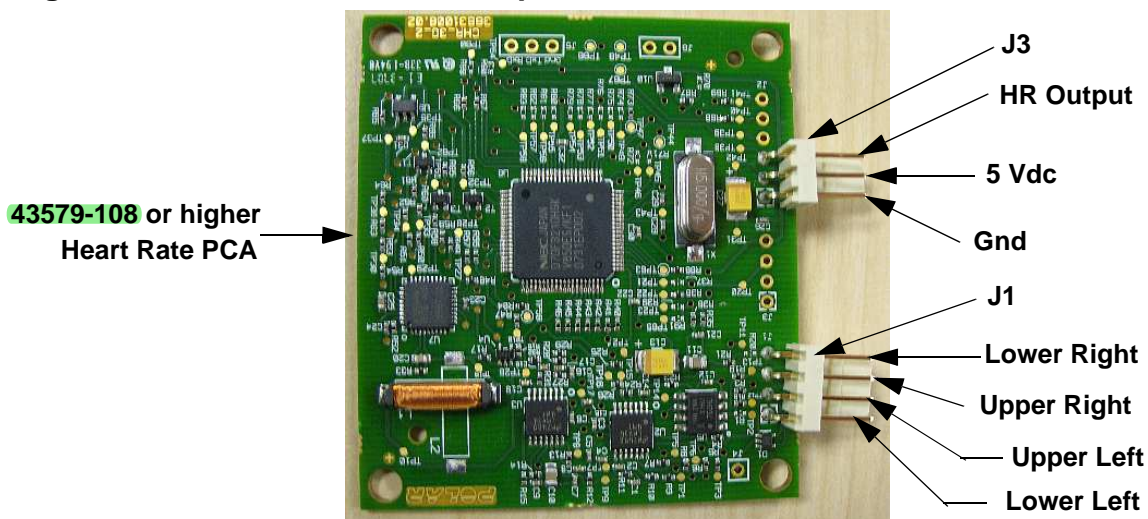

Normal hand held reading - No chest strap reading

1. Access the diagnostic program (Procedure 3.2). Advance to the heart rate display portion of the diagnostic program. Verify that a chest strap signal is not being accepted with either a Polar heart rate test transmitter or a known good chest strap transmitter. If this reading is good, skip to step 3.
2. Using a known good Polar heart rate chest strap, verify that the heart rate operates with the known good chest strap. If the known good Polar chest strap does corrects the problem, replace the original chest strap transmitter.
3. If the above procedures did not correct the problem, replace the heart rate PCA.

No hand held reading - Normal chest strap reading

4. Access the diagnostic program (Procedure 3.2). Advance to the heart rate display portion of the diagnostic program. Verify that a hand held signal is not being accepted by firmly grasping both the right and left hand held contacts on the handlebars. Cover as much of the contact surface area with your hands as possible (without moving your hands), you should receive a heart rate reading within ten seconds.
5. If the hand held signal is now being accepted, something in the near vicinity is radiating RF (radio frequency) energy that is being received by the chest strap portion of the heart rate PCA.
6. If a hand held signal still not being accepted, skip to step 8.
7. Replace the heart rate PCA with a **43579-108** (or higher) heart rate PCA. **43579-108** and higher versions of heart rate PCA are less susceptible to radiated RF energy.
8. Access the diagnostic program (Procedure 3.2). Advance to the heart rate display portion of the diagnostic program. Verify that a hand held signal is not being accepted by firmly grasping both the right and left hand held contacts with the opposite hands, right hand on the left handlebar contacts and left hand on the right handlebar contacts. Cover as much of the contact surface area with your hands as possible, you should receive a heart rate reading within ten seconds. If a hand held signal is still not being accepted, skip to step 10.
9. If a hand held signal was accepted in step 11, the hand held contact wiring is reversed. The end of the wire harness that connects to the hand held contacts in the handlebar is segregated into two groups. One group has blue shrink wrap around it and the other group has black shrink wrap around it. The "blue" group must go to the right hand contacts and the "black" group must go to the left hand contacts. In both groups the black wire must go to the lower contact and the red wire must go to the upper contact. If necessary, rewire the hand held contacts as described above and test as described in step 4.
10. If the wiring is correct, refer to Diagram 6.3 for the following measurements. With an ohmmeter measure between the "lower right contact" pin on the J1 connector and the lower right hand held heart rate contact on the handlebar. The reading should be 1 Ω or less. Measure between the "upper right contact" pin on the J1 connector and the upper right hand held heart rate contact on the handlebar. The reading should be 1 Ω or less. Measure between the "upper left contact" pin on the J1 connector and the upper left hand held heart rate contact on the handlebar. The reading should be 1 Ω or less. Measure between the "lower left contact" pin on the J1 connector and the lower left hand held heart rate contact on the handlebar. The reading should be 1 Ω or less. If any of the above readings are greater than 1 Ω , replace the heart rate PCA to handlebar wire harness.

No hand held reading - No chest strap reading

11. Access the diagnostic program (Procedure 3.2). Advance to the heart rate display portion of the diagnostic program. Verify that neither a chest strap signal or a hand held signal is being accepted with either a heart rate test transmitter or a chest strap transmitter.
12. Check the plug/connector connections on both the heart rate PCA (J4), and upper PCA (J1).
13. If neither a chest strap signal or a hand held signal is being accepted, measure between the "ground" and "5 Vdc" pins on J4 for 5 Vdc. If 5 Vdc is present, replace the heart rate PCA.
14. If 5 Vdc is not present, remove the connector from J4 of the heart rate PCA. Measure between the "ground" and "5 Vdc" pins of the connector (just removed from the heart rate PCA) for 5 Vdc. If 5 Vdc is present, replace the heart rate PCA. If the 5 Vdc is not present, measure between the corresponding pins of J1 on the upper PCA (red and black wires). If 5 Vdc is not present replace the upper PCA. If 5 Vdc is present, replace the upper PCA to heart rate PCA cable.

Constant or intermittent readings when neither the hand held or chest strap is in use

15. Verify that a ferrite core is clamped around the heart rate PCA to upper PCA cable.
16. Constant or intermittent heart rate readings when neither heart rate system is in use is caused by something in the near vicinity radiating RF energy that is being received by the chest strap portion of the heart rate PCA.
17. Replace the heart rate PCA with a **43579-108** (or higher) heart rate PCA. **43579-108** and higher versions of heart rate PCA are less susceptible to radiated RF energy

Procedure 5.6 - Running Belt & Deck Troubleshooting

This procedure is to be used to determine the condition of the running belt and running deck combination. A clamp-on ammeter will be used to measure the treadmill's A.C. input current under load. The A.C. input current is a direct indication of the load being placed on the treadmill. Treadmill loading consists of several factors, the user's weight, treadmill speed, treadmill incline setting and the condition of the running belt and running deck condition. By making all of the other factors consistent we will be able to determine the relative condition of the running belt and deck combination. The A.C. input current measurements will be performed at 3 m.p.h. (4.8 k.p.h.) and 0% incline. Because the loading varies with the user's weight, you should perform the A.C. input current measurement test on a new running belt and deck combination. That will provide you with a benchmark reading to account for your individual weight.

Because the A.C. input current reading will pulse between a high value (during foot plant) and a low reading (between foot plants) we suggest the use of an analog clamp-on ammeter. An analog ammeter makes it very easy to see the A.C. current pulses. The refresh rate on digital ammeters may make it difficult to see the current peaks.

1. Remove the treadmill's motor cover and place the A.C. clamp-on ammeter on the brown wire from the A.C. input module (or A.C. power cord) to the circuit breaker (on/off switch). See the illustration below.

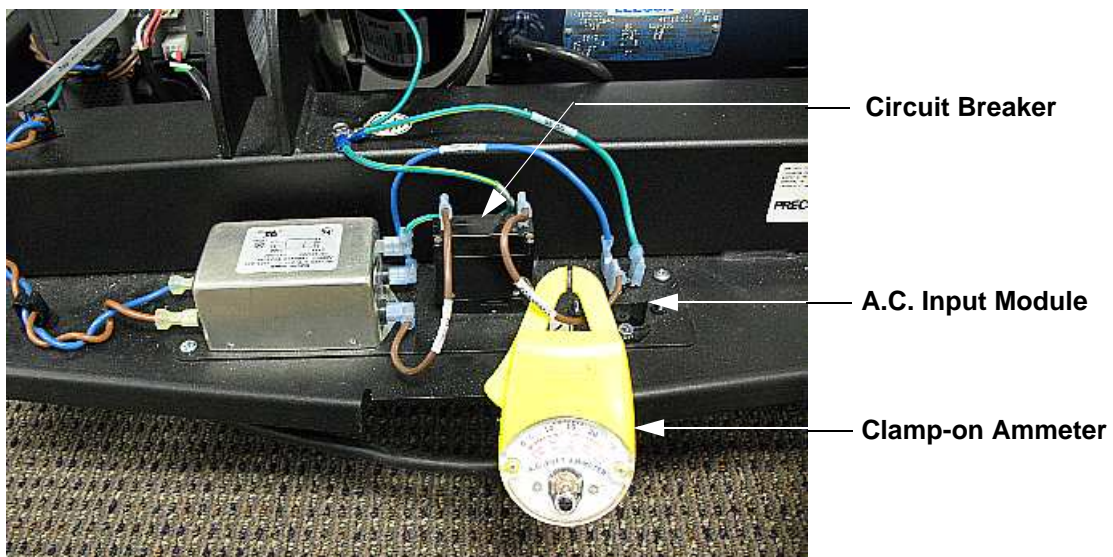

2. Set the treadmill's speed at 3 m.p.h. (4.8 k.p.h.) and the incline at 0%. Walk on the treadmill and observe the peak A.C. current reading. Typical peak A.C. current readings on a new running belt and deck are between 3 and 6 amperes.
3. If the peak current reading approach 20 amperes, the running belt should be replaced. The running deck should be flipped or replaced if the running deck has been previously flipped. See Procedure X for running belt and running deck replacement.

4. If the peak A.C. current readings are greater than on a new running belt and deck combination but not approaching 20 amperes, the reading will give you an indication of the running belt and deck combination's general condition.

Procedure 6.1 - Replacing the Lift Motor

Note:

The replacement lift motor must be calibrated prior to installation. The defective lift motor is then removed and the calibrated replacement lift motor is installed.

1. If the incline is at 0%, skip to step 3.
2. Set the treadmill circuit breaker in the “on” position. Press the **QUICK START** to start the running belt. Use the **INCLINE ▼** key to lower the incline to 0%
3. Set the treadmill circuit breaker in the “off” position and remove the A.C. line cord from the A.C. outlet.
4. Remove the treadmill’s motor cover, disconnect the lift motor plugs from J1 and J8 connectors of the lower logic PCA. See Diagram 5.2. Remove the lift motor’s green frame ground wire from the treadmill’s frame.
5. Lay the replacement lift motor on the floor in front of the treadmill and connect it’s two plugs to the J1 & J8 connectors of the lower logic PCA.
6. Calibrate the lift motor per Procedure 4.1.
7. Lay the treadmill on either its left or right side as convenient.
8. Remove the hitch and clevis pins from the top and bottom of the lift motor. Remove the lift motor from the treadmill.
9. Set the calibrated lift motor in its mounting position. Replace the upper clevis and hitch pins.
10. Replace the lower clevis and hitch pins. It may be necessary to slightly rotate the lift tube to align it so that the clevis pin may be inserted. To align the hole in the lift tube rotate it in the direction that will cause the least amount of rotation to make alignment possible.
11. Route the lift motor cables to the lower PCA. Replace the treadmill’s motor cover.
12. Check treadmill operation per Procedure 3.

Procedure 6.2 - Replacing the Lift Platform

1. Set the treadmill circuit breaker in the “off” position. Remove the A.C. line cord from the A.C. outlet.
2. Remove the treadmill’s motor cover. Carefully, lay the treadmill on it’s right side.
3. Remove the hitch pin and incline motor pin that fastens the lift motor tube to the lift platform. While the lift tube is not fastened to the lift platform, care must be taken to not allow the lift tube to rotate. If the lift tube rotates, the lift motor must be re-calibrated per Procedure 4.1.
4. Remove the hitch pins from the two lift platform pivot pins. Remove the lift platform pivot pins. Remove the lift platform from the treadmill.

Diagram 6.1 - Lift Platform Mounting Pins



5. Set the replacement lift platform in it’s mounting position and replace both pivot pins. Secure the pivot pins with their hitch pins. Replace the incline motor pin and secure it with a hitch pin.
6. Carefully set the treadmill in its upright position and check treadmill operation per Procedure 3.
7. Replace the treadmill’s motor cover.

Procedure 6.3 - Replacing the Lower PCA

1. Set the treadmill circuit breaker in the “off” position. Remove the A.C. line cord from the A.C. outlet.
2. Remove the treadmill’s motor cover.
3. Disconnect the lower PCA drive motor leads (red and black) at the mid-point connector between the lower PCA and the drive, motor. Disconnect Both lift motor connectors (J1 and J8), the speed sensor connector (J3), the drive motor fan connector (J4), and the A.C. input wires from the lower PCA. See Diagram 5.2.
4. Remove both lower PCA mounting screws and remove the lower PCA. See Diagram 6.3.

Diagram 6.3 - Lower PCA

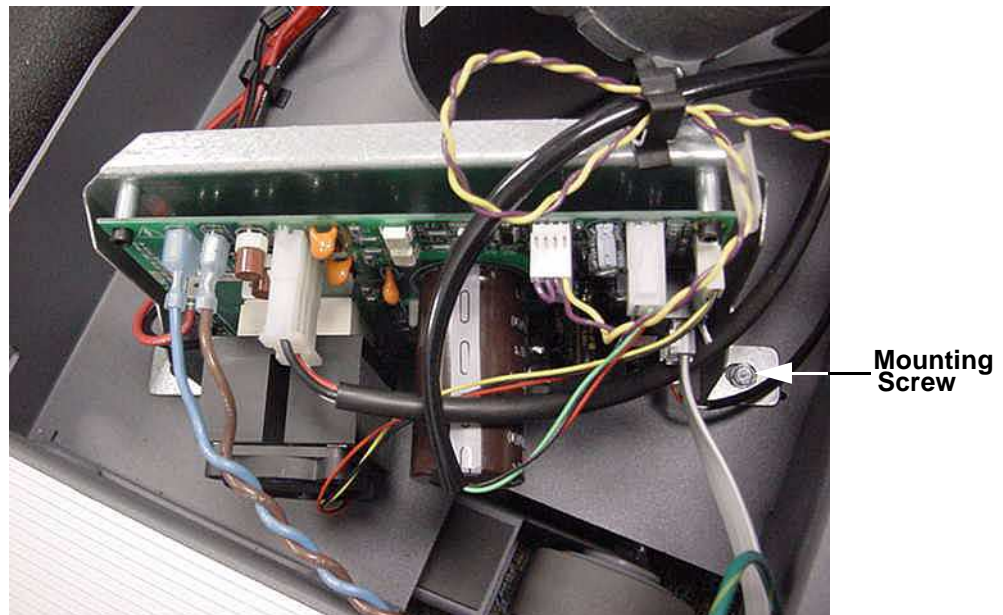

5. Set the replacement lower PCA in its mounting position and fasten it with the screws removed in step 4. Torque the lower PCA mounting screws to 120 inch pounds.
6. The A.C. input wires are the blue and brown wires from A.C. line filter on the front dress panel. Connect the brown A.C. input wire to the M4 terminal and the blue A.C. input wire to the M3 terminal of the lower PCA.
7. Connect the black and red drive motor wires to the mating black and red connectors from the lower PCA.
8. Connect the speed sensor connector to the J3 connector of the lower PCA.
9. Connect the fan connector to the J4 connector of the lower PCA.

10. Connect the incline motor cables to J1 and J8 of the lower PCA.
11. Dress all of the above wiring into the appropriate wire clips along their routing.
12. Insert the A.C. line cord from the A.C. outlet. Set the treadmill circuit breaker in the "on" position.
13. Replace the treadmill's motor cover.
14. Check treadmill operation per Procedure 3.

Procedure 6.10 - Replacing the PROM

1. The PROM and the associated printed circuit assembly (PCA) are static sensitive. Anti-static devices must be used and all anti-static precautions must be followed during this procedure.
2. Remove the printed circuit assembly per its associated procedure.
3. The prom is a forty-four pin square package (PLCC44). This prom should be removed with a proper IC removal tool (see the illustration below)

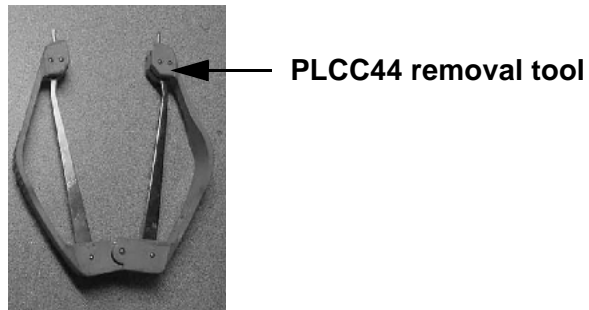

4. The IC's may inserted into their socket by hand by carefully aligning the notch on the IC with the notch on the IC socket and carefully pressing the IC into its socket. See the illustrations below for the alignment notches. Care must be taken that the IC legs on a DIP28 are all aligned in the socket to prevent the legs from bending when inserted. The PLCC44 IC must be carefully aligned squarely in its socket or it will not insert. Do not force the IC into its, socket. If it does not insert easily, remove the it and re-align it in its socket.

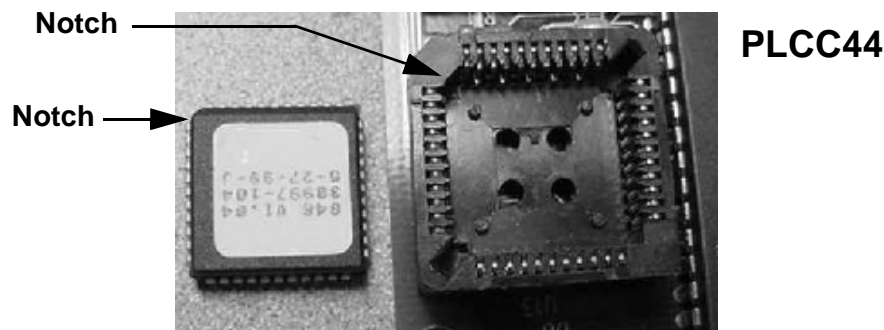

Procedure 6.4 - Replacing the Speed Sensor

1. Set the treadmill circuit breaker in the “off” position. Remove the A.C. line cord from the A.C. outlet.
2. Remove the treadmill’s motor cover.
3. Disconnect the plug from the J3 connector on the lower PCA.
4. Rotate the flywheel so that the speed sensor is between flywheel lobes.
5. Remove the screw that fastens the speed sensor to the treadmill drive motor. See Diagram 6.4.

Diagram 6.4 - Speed Sensor Mounting.

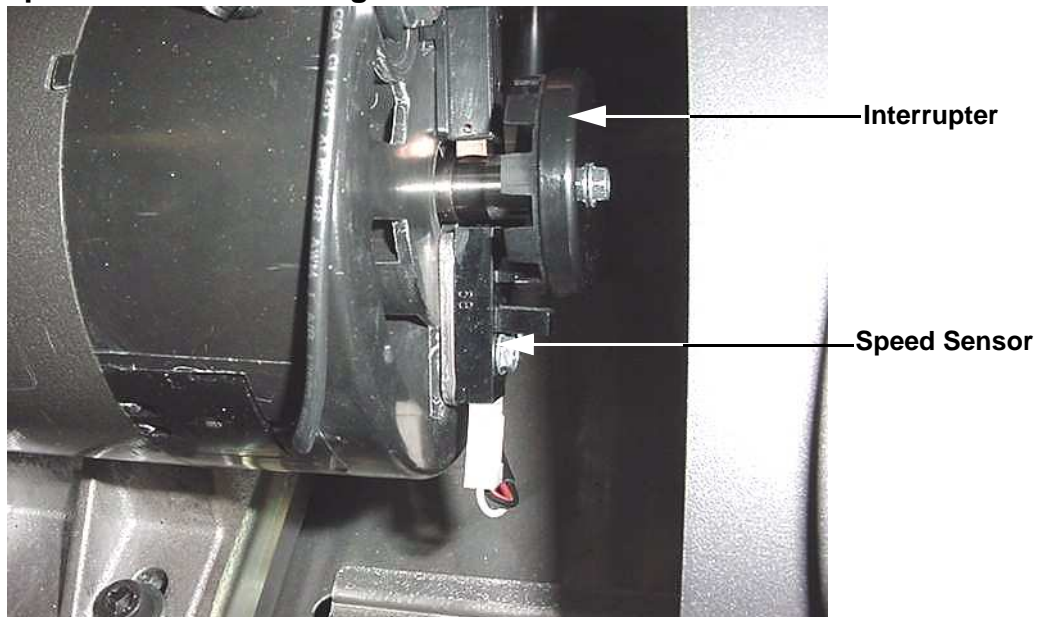

6. Set the replacement speed sensor in its mounting position and fasten it with the screw removed in step 4. Torque the screw to 25 inch pounds.
7. Connect the speed sensor connector to the J3 connector of the lower PCA.
8. Slowly rotate the flywheel to ensure that the flywheel lobes do not contact the speed sensor.
9. Set the treadmill circuit breaker in the “on” position and check treadmill operation per Procedure 3.
10. Replace the treadmill’s motor cover.

Procedure 6.5 - Replacing Drive Motor

1. Set the treadmill circuit breaker in the “off” position and unplug the treadmill’s line cord from the A.C. outlet.
1. Remove the treadmill’s motor cover.
2. The drive motor, speed sensor tooth wheel and flywheel are balanced as a matched pair. Since the flywheel is balanced to a specific motor, flywheels and speed sensor tooth wheel should not be removed from one and installed on a different motor. If the drive motor is replaced, the drive motor, speed sensor tooth wheel and flywheel should be replaced as a unit.
3. Remove the screw that fastens the speed sensor to the treadmill drive motor. See Diagram 6.4. Move the speed sensor as far from the drive motor as possible.
4. Disconnect the red and black drive motor wires at the mid-point connector between the drive motor and the lower PCA.
5. Loosen the four drive motor mounting bolts. See Diagram 4.3. Remove the drive belt from the drive motor pulley.
6. Set the drive motor in it’s rear most mounting position (toward roller). Replace and hand tighten the drive motor mounting screws removed in step 6. Roll the drive belt in place on the drive motor pulley.
7. Tension the drive belt and mount the drive motor per Procedure 4.2.
8. Connect the black and red drive motor wires to the mating black and red connectors on the lower PCA.
9. Set the speed sensor in its mounting position on the drive motor and fasten with the screw removed in step 3. Torque the mounting screws to 25 inch pounds.
10. Re-install the motor cover.
11. Check treadmill operation per Procedure 3.

Procedure 6.6- Replacing the Circuit Breaker

1. Set the treadmill circuit breaker in the “off” position and unplug the treadmill’s line cord from the A.C. outlet.
2. Remove the treadmill’s motor cover.
3. Remove the four screws that fasten the mounting panel to the treadmill.

Diagram 6.5 - Treadmill Dress Panel (Rear View)

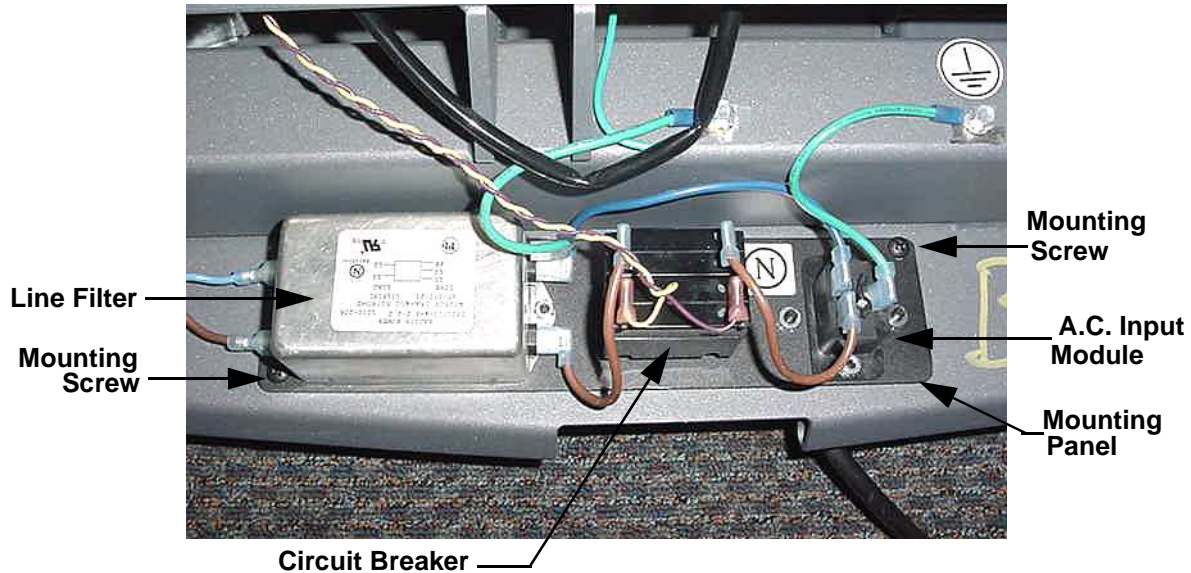

4. Note where both brown wires, the yellow wire and the violet wire are connected to the circuit. Disconnect all four wires from the circuit breaker.
5. Lift the mounting panel from the treadmill frame to access the bottom side of the mounting panel.
6. Note the orientation of the circuit breaker in the dress panel. The replacement circuit breaker must be mounted in the same orientation. Remove the circuit breaker mounting screws. Remove the circuit breaker from the treadmill.
7. Set the replacement circuit breaker in the “OFF” position, to prevent the treadmill from starting immediately when the line cord is inserted in the wall A.C. outlet. Fasten the circuit breaker to the mounting panel using the screws removed in step 6.
8. Connect the two brown, yellow and violet wires as noted in step 4.
9. Set the mounting panel in its mounting position, fasten it with the screws removed in step 3.
10. Replace the treadmill’s motor cover. Check treadmill operation per Section 3.

Procedure 6.7 - Replacing the Line Filter

1. Set the treadmill circuit breaker in the “off” position and unplug the treadmill’s line cord from the A.C. outlet.
2. Remove the treadmill’s motor cover.
3. Make note of where the two blue, two brown and green/yellow are connected to the line filter. See Diagram 6.5. Disconnect all of the wiring from the line filter.
4. Remove the mounting hardware that fastens the line filter to the mounting panel and remove the line filter.
5. Set the replacement line filter in it’s mounting position, the side with three terminals must face the circuit breaker. Fasten the line filter to the mounting panel with the mounting hardware removed in step 3.
6. Connect the wiring to the line filter as noted in step 3.
7. Replace the treadmill’s motor cover.
8. Check treadmill operation per Section 3.

Procedure 6.8 - Replacing the A.C. Input Module

1. Set the treadmill circuit breaker in the "off" position and unplug the treadmill's line cord from the A.C. outlet.
2. Remove the treadmill's motor cover.
3. Remove the four screws that fasten the mounting panel to the treadmill. See Diagram 6.5.
4. Lift the mounting away from the frame to access the bottom side of the mounting panel.
5. Remove the two screws fastening the line cord retaining bracket to the mounting panel. Remove the retaining bracket. Remove the line cord from the A.C. input module.
6. Note where the brown, blue and green/yellow wire are connected to the A.C. input module. Remove all of the wiring from the A.C. input module.
7. Remove the hardware fastening the A.C. input module to the mounting panel.
8. Set the replacement A.C. input module in its mounting position and fasten it with the hardware removed in step 6.
9. Insert the line cord in the A.C. input module. Replace the line cord retaining bracket and fasten it with the hardware removed in step 5.
10. Set the mounting panel in its mounting position and fasten it with the hardware removed in step 3.
11. Replace the treadmill's motor cover.
12. Insert the line cord in the A.C. outlet. Check treadmill operation per Section 3.

Procedure 6.9 - Replacing the Drive Motor Brushes (Pacific Scientific Motor Only)

1. Set the treadmill circuit breaker in the "off" position and unplug the treadmill's line cord from the A.C. outlet.
2. Remove the treadmill's motor cover.
3. Remove the screws that retain the drive motor brush cover. Carefully, remove the heavy paper cover from the brush access opening.
4. Disconnect the brush wire from the tab on the brush housing. Remove the brush spring by depressing the tab on the brush spring.
5. Remove the brush from it's brush holder. See Diagram 6.6.

Diagram 6.6 - Drive Motor Brush

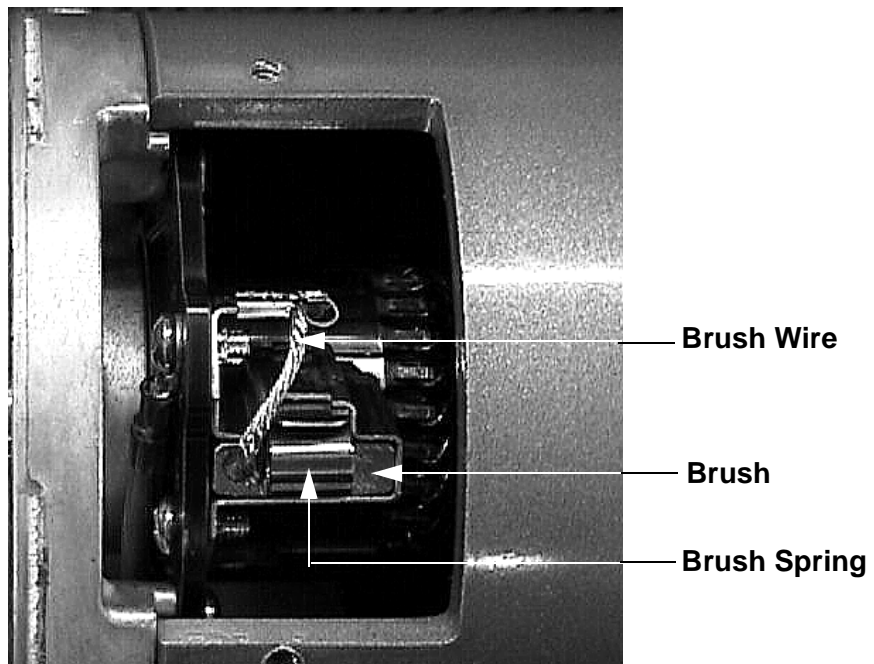

6. Slide the replacement brush into the brush holder. Be sure that the angled edge of the brush is oriented so that the brush face makes full contact with the motor commutator.
7. Reinstall the brush spring and connect the brush wire to the tab on the brush holder.
8. Replace the heavy paper cover in the brush access opening. Replace the brush cover and fasten it with the screws removed in step 3.
9. Repeat 3-8 with remaining drive motor brush.

10. Replace the treadmill's motor cover.
11. Check treadmill operation per Procedure 3.

Procedure 6.10 - Drive Roller Replacement

This procedure is to be used to replace a drive roller while maintaining the drive belt's original tensioning and the running belt's original tension and tracking settings. Two running belt gauges, Precor part number 20007-101, are required. It is important that this procedure be followed to maintain correct drive belt and running belt tension. When tension is removed from the running belt, the belt requires 24 hours for it to "relax". If tension is removed from the belt and then re-tensioned without following this procedure or allowing a 24 hour relaxation period, the running belt may be over tensioned. Over tensioning the belt will lead to premature running belt wear, premature driver roller bearing failure and premature take up roller bearing failure.

1. Place two running belt gauges on each side of the running belt, being sure that the gauges are not across a belt seam. Set the gauges to the 3% mark as shown in the Illustration below.

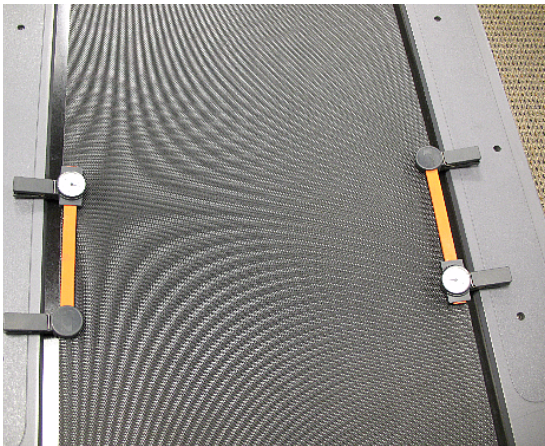

2. Once set the belt gauges can not be disturbed or moved, doing so will invalidate the tension settings and necessitate a 24 hour relaxation period before the running belt can be re-tensioned.
3. Remove the end caps from the rear of treadmill to expose the take up roller mounting bolts. Remove the treadmill's motor cover.
4. Loosen, but do not remove the take up roller mounting bolts. The bolts are being loosened to remove tension from the running belt.

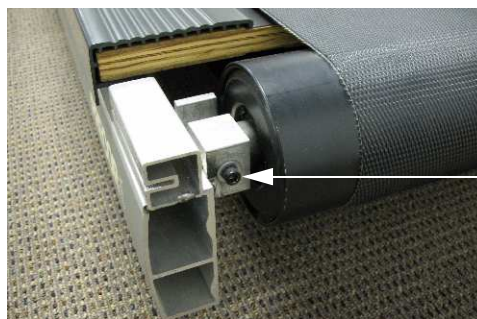

**Take Up Roller
Mounting Bolt**

5. Slowly rotate the drive motor flywheel while pressing the drive belt off of the drive roller pulley. Continue until the drive belt “walks” completely off of the drive roller pulley.

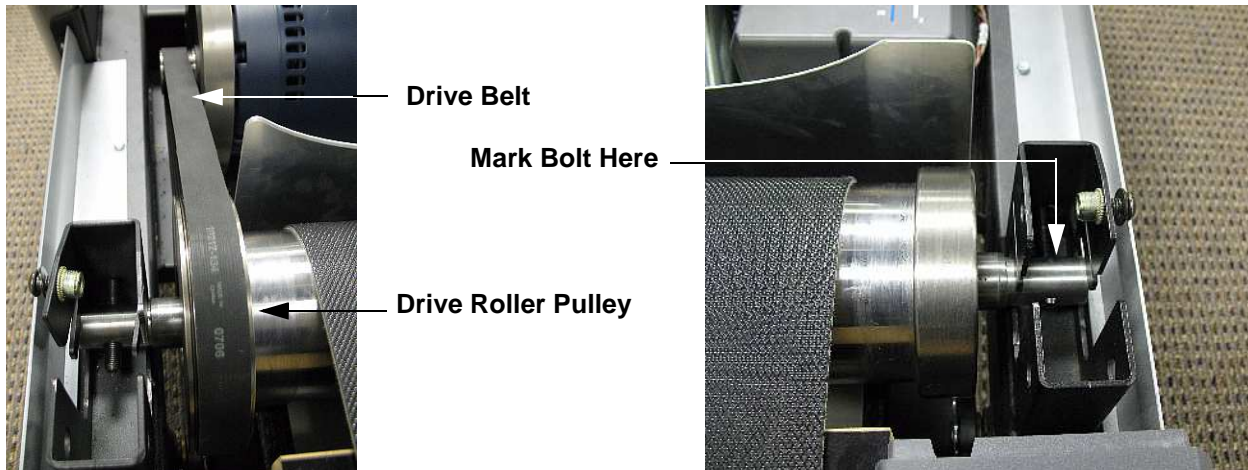

6. Using a fine tip marker or scribe, place a mark on the right hand drive roller mounting bolt directly in front of the drive roller shaft. The bolt is being marked so that the drive roller can be returned to the exact same position. The use of a fine marking line allows for more accuracy when the replacement drive roller is installed.
7. Remove both drive roller mounting bolts. Remove the drive roller from the treadmill.
8. Slide the replacement drive roller into running belt and into the drive belt. Hand start both drive roller mounting bolts.
9. Tighten the left hand drive roller bolt fully. The left hand side of the drive roller should be as far forward as possible.
10. Tighten the right hand drive roller bolt until the mark placed on it in step 6 aligns with the front edge of the drive roller shaft. Steps 8 and 9 should place the drive roller into its original position and should now be square to the treadmill frame.
11. Slowly rotate the drive motor flywheel while pressing the drive belt onto of the drive roller pulley. Continue until the drive belt “walks” completely onto the drive roller pulley. Be sure that the drive belt is fully onto and correctly aligned on the drive roller pulley.
12. Alternate tightening the two take up roller mounting bolts, in order to tighten both ends evenly, until both running belt gauges again read exactly 3%.
13. When both gauges again read 3% the belt is at its original tension. It will now be necessary to touch up the running belt tracking, however if this procedure was carefully followed, the belt tracking should be very close.
14. Remove both belt gauges from the running belt.
15. Start the treadmill and operate it at 2 m.p.h. Observe the running belt. If the belt drifts away from its centered position re-track it by adjusting the take up roller mounting bolts as described in step 16.

16. If the belt drifts to the right, slowly turn the right hand mounting bolt clockwise until the drifting stops. If the belt drifts to the left, slowly turn the left hand mounting bolt clockwise until the drifting stops. Only a very small adjustment should be required, 1/8 to 1/4 turn.
17. Increase the treadmill speed to 4 m.p.h., if the belt drifts away from center, touch up the tracking as described in step 18.
18. If the belt drifts to the right, slowly turn the left hand mounting bolt counter-clockwise until the drifting stops. If the belt drifts to the left, slowly turn the right hand mounting bolt counter-clockwise until the drifting stops. Only a very small adjustment should be required, 1/8 to 1/4 turn.
19. Increase the treadmill speed to 8 m.p.h., if the belt drifts away from center, track it as described in step 16.
20. Increase the treadmill speed to maximum, if the belt drifts away from center, track it as described in step 18.
21. Set the treadmill at a comfortable running speed and run on the treadmill for a couple of minutes and note the running belt tracking. If required track it as described in step 16. Replace the end caps and motor cover removed in step 3.

Procedure 6.11 - Take Up Roller Replacement

This procedure is to be used to replace a take up roller while maintaining the running belt's original tension and tracking settings. Two running belt gauges, Precor part number 20007-101, are required. It is important that this procedure be followed to maintain correct running belt tension. When tension is removed from the running belt, the belt requires 24 hours for it to "relax". If tension is removed from the belt and then re-tensioned without following this procedure or allowing a 24 hour relaxation period, the running belt may be over tensioned. Over tensioning the belt will lead to premature running belt wear, premature driver roller bearing failure and premature take up roller bearing failure.

1. Place two running belt gauges on each side of the running belt, being sure that the gauges are not across a belt seam. Set the gauges to the 3% mark as shown in the Illustration below.

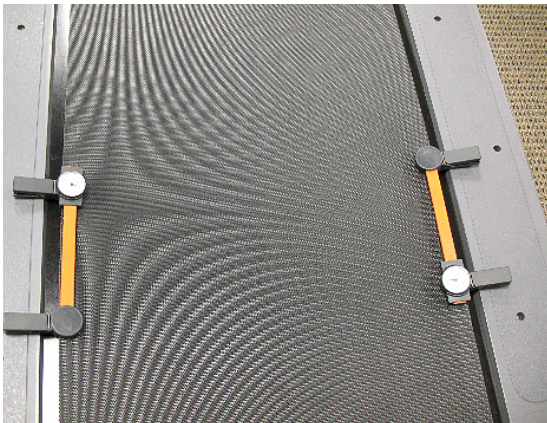

2. Once set the belt gauges can not be disturbed or moved, doing so will invalidate the tension settings and necessitate a 24 hour relaxation period before the running belt can be re-tensioned.
3. Remove the end caps from the rear of treadmill to expose the take up roller mounting bolts.
4. If applicable, remove the finger guard located in front of take up roller.
5. Remove both take up roller mounting bolts. The belt gauge readings will decrease as the take up roller mounting bolts are removed. Remove the take up roller from the treadmill.

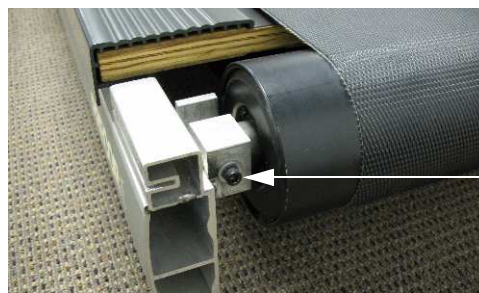

**Take Up Roller
Mounting Bolt**

6. Slide the replacement take up roller into the running belt and set it in its mounting position. Hand start both take up roller mounting bolts that were removed in step 5.
7. Alternate tightening the two take up roller mounting bolts, in order to tighten both ends evenly, until both running belt gauges again read exactly 3%.
8. When both gauges again read 3% the belt is at its original tension. It will now be necessary to touch up the running belt tracking, however if this procedure was carefully followed, the belt tracking should be very close.
9. Remove both belt gauges from the running belt.
10. Start the treadmill and operate it at 2 m.p.h. Observe the running belt. If the belt drifts away from its centered position re-track it by adjusting the take up roller mounting bolts as described in step 11.
11. If the belt drifts to the right, slowly turn the right hand mounting bolt clockwise until the drifting stops. If the belt drifts to the left, slowly turn the left hand mounting bolt clockwise until the drifting stops. Only a very small adjustment should be required, 1/8 to 1/4 turn.
12. Increase the treadmill speed to 4 m.p.h., if the belt drifts away from center, touch up the tracking as described in step 13.
13. If the belt drifts to the right, slowly turn the left hand mounting bolt counter-clockwise until the drifting stops. If the belt drifts to the left, slowly turn the right hand mounting bolt counter-clockwise until the drifting stops. Only a very small adjustment should be required, 1/8 to 1/4 turn.
14. Increase the treadmill speed to 8 m.p.h., if the belt drifts away from center, track it as described in step 11.
15. Increase the treadmill speed to maximum, if the belt drifts away from center, track it as described in step 13.
16. Set the treadmill at a comfortable running speed and run on the treadmill for a couple of minutes and note the running belt tracking. If required track it as described in step 11.
17. If applicable, replace the finger guard removed in step 4.
18. Replace the end caps removed in step 3.

Procedure 6.12 - Running Belt and/or Deck Replacement

This procedure is to be used to replace the running belt and/or deck while maintaining the drive belt's original tensioning and setting the running belt's tension and tracking. Two running belt gauges, Precor part number 20007-101, are required. It is important that this procedure be followed to maintain correct drive belt and running belt tension. Over tensioning the belt will lead to premature running belt wear, premature driver roller bearing failure and premature take up roller bearing failure. This procedure addresses decks that can be flipped, however it is important to note that only double sided decks can be flipped. Single sided decks must be replaced.

1. Remove the end caps from the rear of treadmill to expose the take up roller mounting bolts.
2. Remove the treadmill's motor cover.
3. If applicable, remove the finger guard from in front of the take up roller.
4. Remove both take up roller mounting bolts. Remove the take up roller from the treadmill.

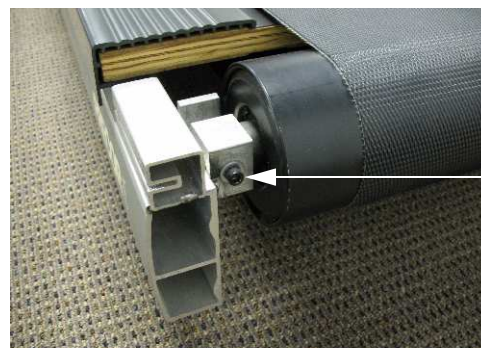

**Take Up Roller
Mounting Bolt**

5. Slowly rotate the drive motor flywheel while pressing the drive belt off of the drive roller pulley. Continue until the drive belt "walks" completely off of the drive roller pulley.



Drive Belt

Mark Bolt Here

Drive Roller Pulley

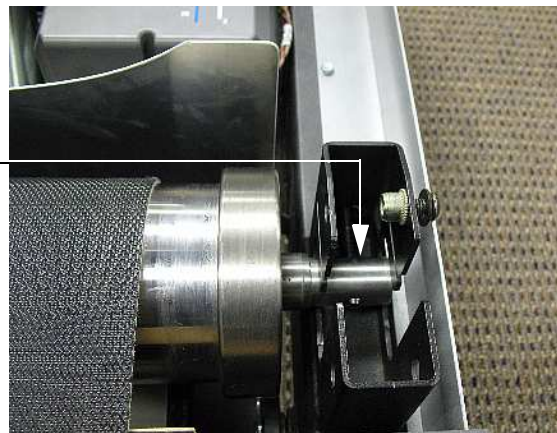

6. Using a fine tip marker or scribe, place a mark on the right hand drive roller mounting bolt directly in front of the drive roller shaft. The bolt is being marked so that the drive roller can be returned to the exact same position. The use of a fine marking line allows for more

accuracy when the replacement drive roller is installed.

7. Remove both drive roller mounting bolts. Remove the drive roller from the treadmill.
8. Remove the running belt and deck from the treadmill. If both sides of the deck have been used, discard the deck. If the bottom side of the deck has not been used, flip the deck so that when it is replaced it will now be the top side.
9. Decks with inserts that are being flipped need to be reversed so that the bottom of the deck can be used, the inserts can be removed by threading the deck screw into the insert from the top. Using a hammer or mallet the insert can be tapped out the bottom of the deck. Remove the insert from the deck screw. Using one of the **CATN025-150** bolts and a flat washer, to cover the hole, thread the bolt into the insert and pull the insert into the opposite side of the deck until the insert is flush with the deck surface. Repeat this procedure with the remaining five inserts.
10. Using a clean, dry cloth, wipe the top surface of the deck clean of any dirt, dust or debris. Set the replacement or flipped deck inside of the replacement running belt. Set the running belt and deck combination in its mounting position on the treadmill.
11. Place two running belt gauges on each side of the running belt, being sure that the gauges are not across a belt seam. Set the gauges to the 3% mark as shown in the Illustration below

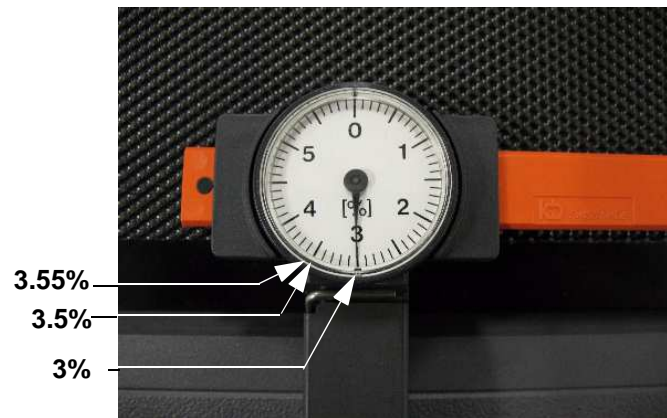
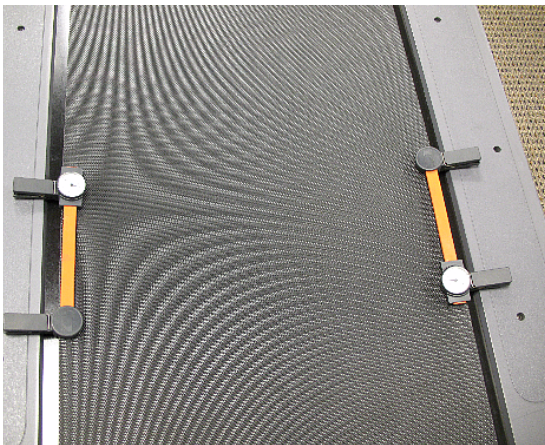

12. Slide the drive roller into running belt and into the drive belt. Hand start both drive roller mounting bolts.
13. Tighten the left hand drive roller bolt fully. The left hand side of the drive roller should be as far forward as possible.
14. Tighten the right hand drive roller bolt until the mark placed on it in step 5 aligns with the front edge of the drive roller shaft.
15. Steps 12 and 13 should place the drive roller into its original position and should now be square to the treadmill frame.

16. Slowly rotate the drive motor flywheel while pressing the drive belt onto of the drive roller pulley. Continue until the drive belt “walks” completely onto of the drive roller pulley. Be sure that the drive belt is fully onto and correctly aligned on the drive roller pulley.
17. Slide the take up roller into the running belt and set it in its mounting position. Hand start both take up roller mounting bolts that were removed in step 2.
18. Alternate tightening the two take up roller mounting bolts, in order to tighten both ends evenly, until both running belt gauges again read exactly 3.5% on consumer treadmills or 3.55% on commercial treadmills.
19. When both gauges again read 3.5 or 3.55% the belt is at its original tension. It will now be necessary to touch up the running belt tracking, however if this procedure was carefully followed, the belt tracking should be very close.
20. Remove both belt gauges from the running belt.
21. Start the treadmill and operate it at 2 m.p.h. Observe the running belt. If the belt drifts away from its centered position re-track it by adjusting the take up roller mounting bolts as described in step 21.
22. If the belt drifts to the right, slowly turn the right hand mounting bolt clockwise until the drifting stops. If the belt drifts to the left, slowly turn the left hand mounting bolt clockwise until the drifting stops. Only a very small adjustment should be required, 1/8 to 1/4 turn.
23. Increase the treadmill speed to 4 m.p.h., if the belt drifts away from center, touch up the tracking as described in step 23.
24. If the belt drifts to the right, slowly turn the left hand mounting bolt counter-clockwise until the drifting stops. If the belt drifts to the left, slowly turn the right hand mounting bolt counter-clockwise until the drifting stops. Only a very small adjustment should be required, 1/8 to 1/4 turn.
25. Increase the treadmill speed to 8 m.p.h., if the belt drifts away from center, track it as described in step 21.
26. Increase the treadmill speed to maximum, if the belt drifts away from center, track it as described in step 23.
27. Set the treadmill at a comfortable running speed and run on the treadmill for a couple of minutes and note the running belt tracking. If required track it as described in step 21.
28. If applicable, replace the finger guard removed in step 2.
29. Replace the end caps and motor cover removed in step 1.

Procedure 6.13 - Replacing Drive Motor Brushes (McMillan Motor Only)

1. Set the treadmill's on/off switch in the "off" position and remove the treadmill's power cord from the A.C. outlet.
2. Remove the treadmill's motor cover.
3. Remove the bolts that retain the treadmill's power input panel and carefully move it out of the way to gain clearance to the front of the drive motor.
4. Disconnect the motor brush wires from the Lower PCA wires. Remove the cable clamp from the drive motor and remove the brush wires from the cable clamp. Remove the brush wires from the cable clamp on the lift support bracket. See the illustration below.

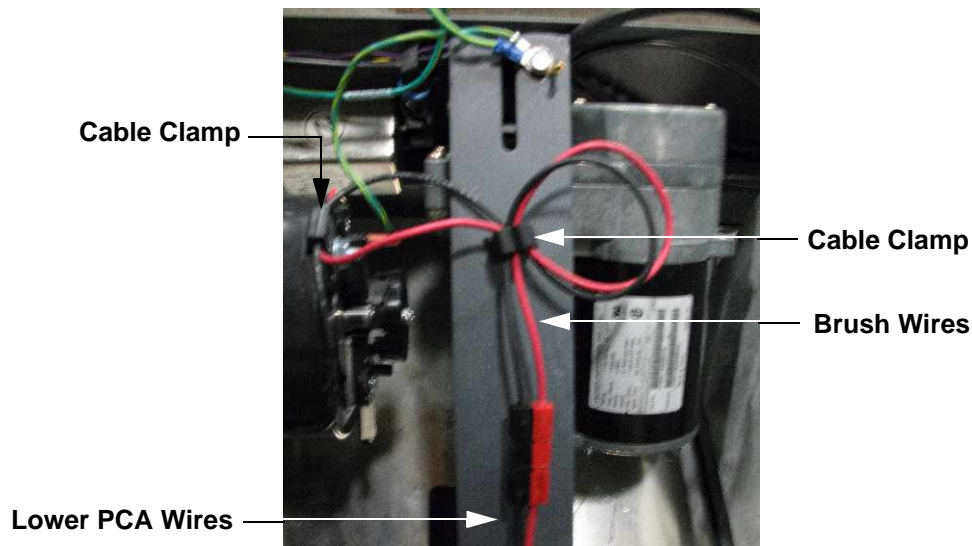

5. Be sure to note that the black brush wire enters the drive motor in the rear and the red brush wire enters the drive motor from the front.
6. Using a flat bladed screwdriver, remove the front and rear motor brush covers. Remove and discard both brushes.
7. Set the replacement motor brush with the red wire in its mounting position in the front of the drive motor. Set the replacement motor brush with the black wire in its mounting position in the rear of the drive motor.
8. Press the brush spring and ferrule into the opening in the motor, feed the brush wire into the notch in the brush cover then snap the brush cover back into place. The entire motor brush spring and ferrule must be inside the motor. Repeat this procedure for the remaining motor brush. See the illustration below.

- Place the brush wires in the drive motor cable clamp and fasten the cable clamp to the drive motor with the hardware removed in step 4. Place the brush wires in the cable clamp on the lift motor support and loop them to take up extra wire length as shown in the illustration above.

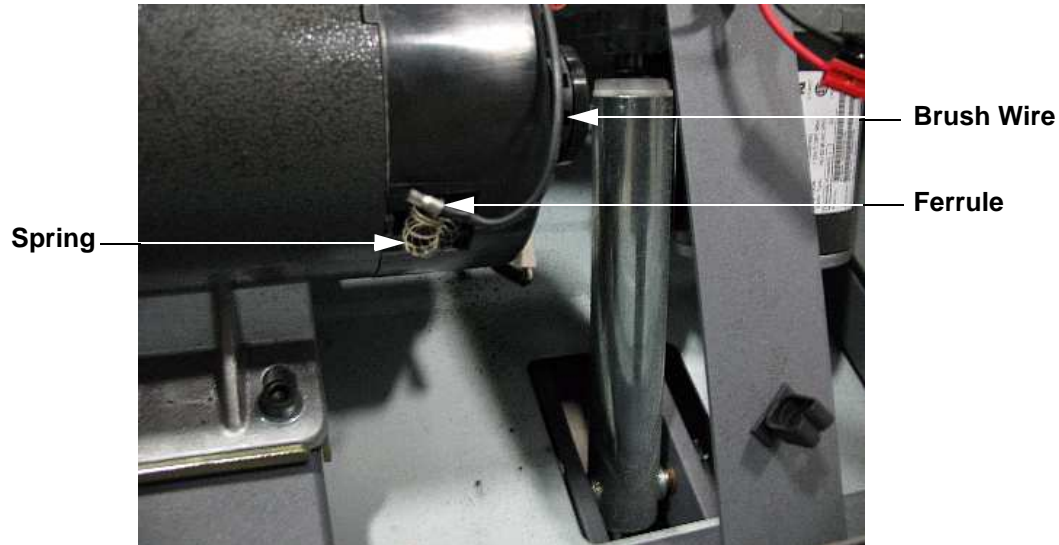

- Reconnect the brush wires to the lower PCA wires.
- Set the power input panel in its mounting position and fasten it with the hardware removed in step 3.
- Replace the treadmill's motor cover.
- Insert the treadmill's A.C. power cord into the A.C. outlet and set the treadmill's on/off switch in the "on" position.
- Thoroughly test all treadmill functions per Section Three.

Wiring Diagram 7.1 - 9.31, 9.33, 9.35

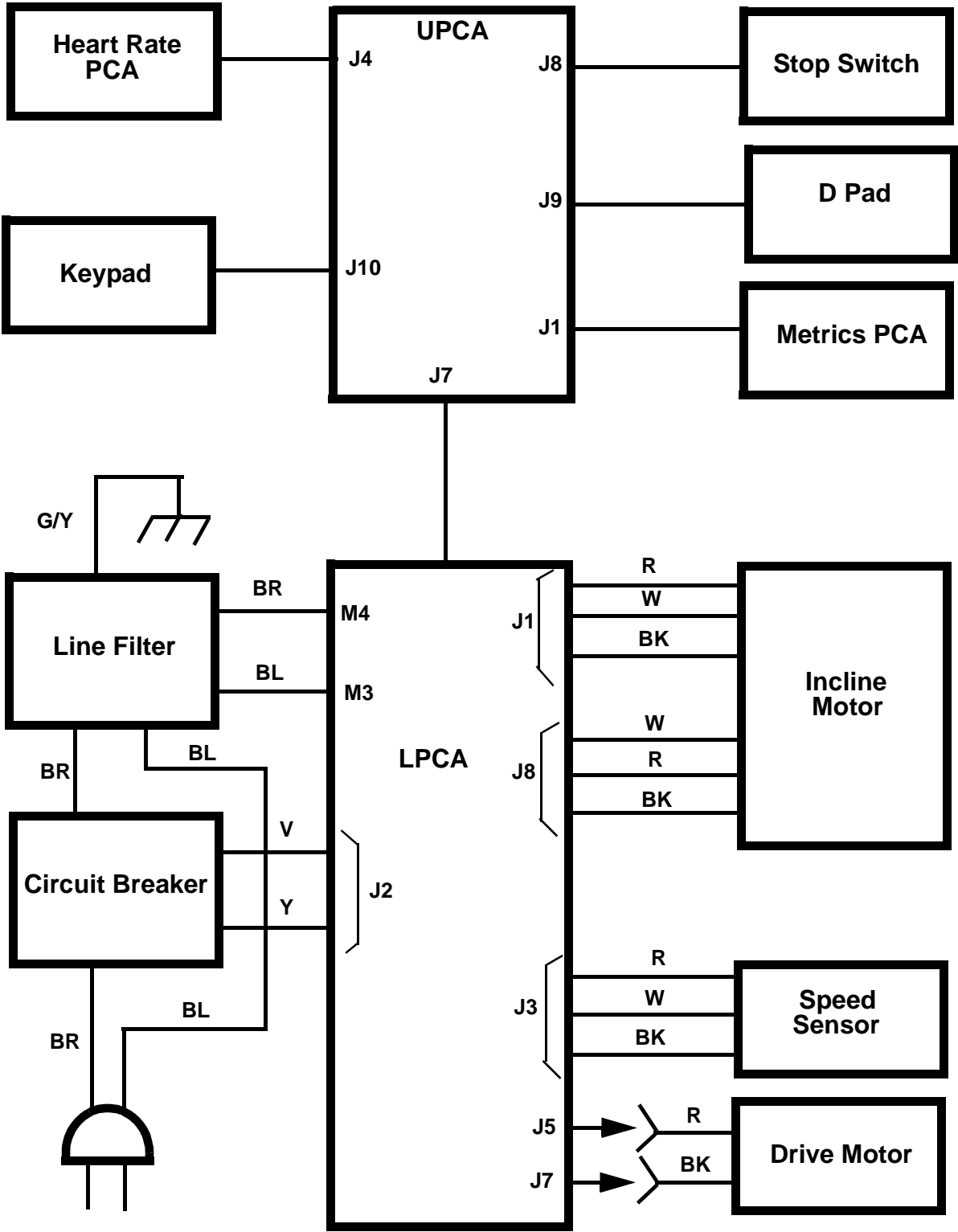

Block Diagram 7.2 - 9.31, 9.33, 9.35



9.31-07, 9.33-07, 9.35-07 PWM Treadmill

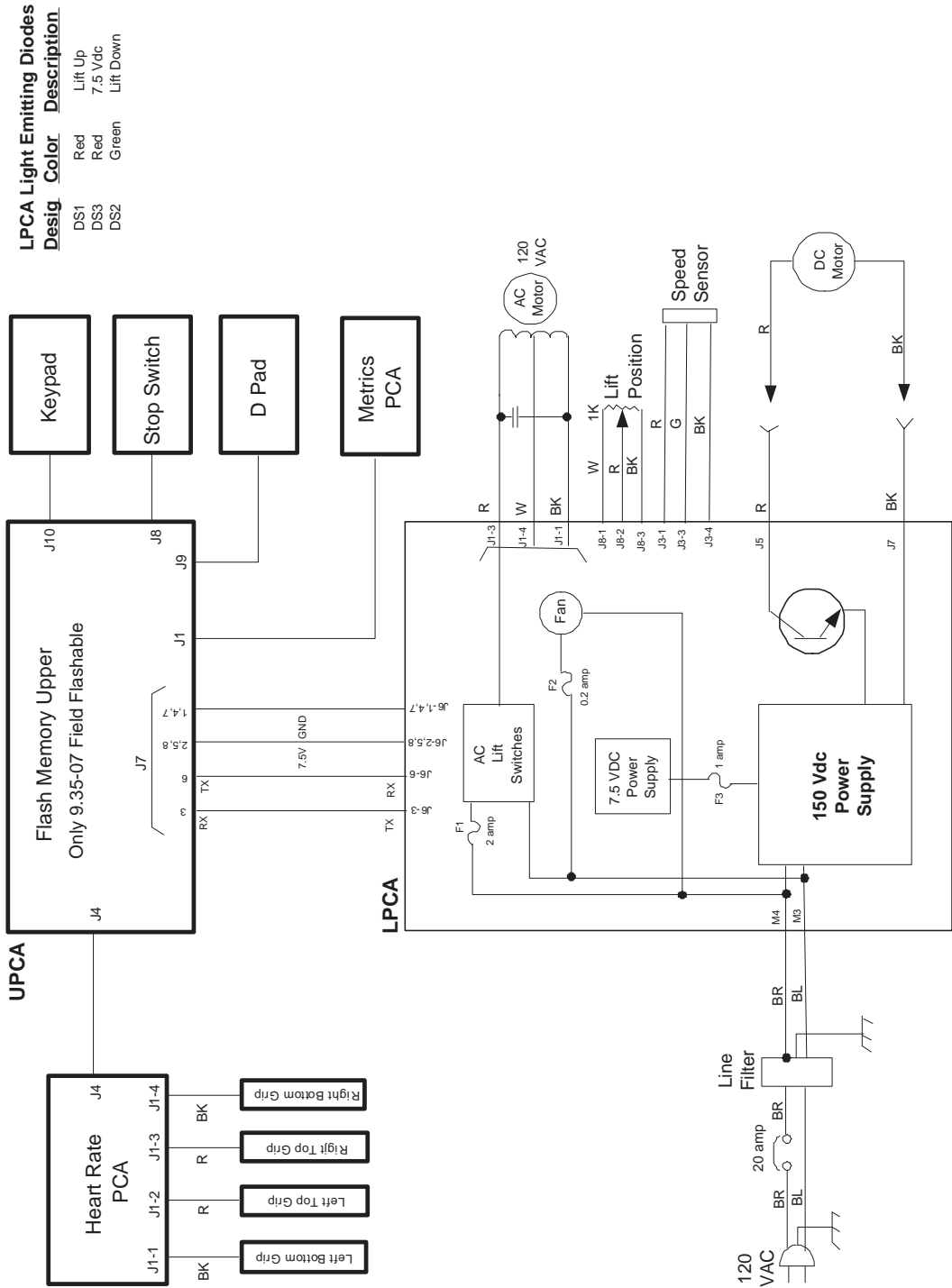

LPCA Light Emitting Diodes

Desig	Color	Description
DS1	Red	Lift Up
DS3	Red	7.5 Vdc
DS2	Green	Lift Down