

LIFE FITNESS ATTACHABLE TV SYSTEM

USER'S MANUAL

02/2010 M051-00K71-D001



Life Fitness
WHAT WE LIVE FOR

CORPORATE HEADQUARTERS

5100 River Road Schiller Park, Illinois 60176 • U.S.A.
847.288.3300 • FAX: 847.288.3703
800.735.3867 (Toll-free within U.S.A., Canada)

Global Website: www.lifefitness.com

AMERICAS

North America

Life Fitness Inc.

5100 N River Road
Schiller Park, IL 60176 U.S.A
Telephone: (847) 288 3300
Fax: (847) 288 3703
Service Email:
commercialservicereply@lifefitness.com
Sales/Marketing Email:
commercialsales@lifefitness.com
Operating Hours: 7:00 am-6:00 pm (CST)

Brazil

Life Fitness Brasil

Av. Cidade Jardim, 900-Itaim
Sao Paulo, SP
01454-000
BRAZIL
SAC: (800) 773 8282
Telephone: (+55) 11.3095.5200
Fax: (+55) 11.3095.5201
Service Email: suporte@lifefitness.com.br
Sales/Marketing Email: lifefitness@lifefitness.com.br
Operating Hours: 8:30 am-17:30 pm (BRT)

Latin America & Caribbean*

Life Fitness Inc.

5100 N River Road
Schiller Park, IL 60176 U.S.A
Telephone: (847) 288 3300
Fax: (847) 288 3703
Service Email: customersupport@lifefitness.com
Sales/Marketing Email:
commercialsales@lifefitness.com
Operating Hours: 7:00am-6:00pm (CST)

EUROPE, MIDDLE EAST, & AFRICA (EMEA)

Netherlands & Luxemburg

Life Fitness Atlantic BV

Bijdorplein 25-31
2992 LB Barendrecht
THE NETHERLANDS
Telephone: (+31) 180 646 666
Fax: (+31) 180 646 699
Service Email:
internationalservicesupport@lifefitness.com
Sales/Marketing Email:
marketing.benelux@lifefitness.com
Operating Hours: 9.00h-17.00h (CET)

United Kingdom & Ireland

Life Fitness UK LTD

Queen Adelaide
Ely, Cambs, CB7 4UB
Telephone: General Office (+44) 1353.666017
Customer Support (+44) 1353.665507

Fax: (+44) 1353.666018
Service Email: uk.support@lifefitness.com
Sales/Marketing Email: life@lifefitness.com
Operating Hours:
General Office: 9.00am - 5.00pm (GMT)
Customer Support: 8.30am - 5.00pm (GMT)

Germany & Switzerland

Life Fitness Europe GMBH

Siemensstrasse 3
85716 Unterschleißheim
GERMANY
Telephone: (+49) 89.31 77 51.0 (Germany)
(+41) 0848 000 901 (Switzerland)
Fax: (+49) 89.31 77 51.99 (Germany)
(+41) 043 818 07 20 (Switzerland)
Service Email: kundendienst@lifefitness.com
Sales/Marketing Email:
kundenberatung@lifefitness.com
Operating Hours: 9.00h-17.00h (MEZ)

Austria

Life Fitness Austria

Vertriebs G.m.b.H.
Dückerstrasse 7-9/3/36
1220 Vienna
AUSTRIA
Telephone: (+43) 1.61.57.198
Fax: (+43) 1.61.57.198.20
Service Email: kundendienst@lifefitness.com
Marketing/Sales Email:
kundenberatung@lifefitness.com
Operating Hours: 9.00h-17.00h (MEZ)

Spain

Life Fitness IBERIA

C/Frederic Mompou 5, 1ª^a
08960 Sant Just Desvern Barcelona
SPAIN
Telephone: (+34) 93.672.4660
Fax: (+34) 93.672.4670
Service Email: info.iberia@lifefitness.com
Sales/Marketing Email: info@lifefitness.com
Operating Hours:
9.00h-18.00h (Monday-Thursday)
8.30h-15.00h (Friday)

Italy

Life Fitness ITALIA S.R.L.

Via Crivellini 7/N
37010 Affi Verona
ITALY
Telephone: (+39) 045.7237811
Fax: (+39) 045.7238197
Service Email: assistenza@lifefitness.com
Sales/Marketing Email: info@lifefitnessitalia.com
Operating Hours: 8.30h -18.00h (CET)

Belgium

Life Fitness Benelux NV

Parc Industriel de Petit-Rechain
4800 Verviers

BELGIUM

Telephone: (+32) 87 300 942
Fax: (+32) 87 300 943
Service Email:
internationalservicesupport@lifefitness.com
Sales/Marketing Email:
marketing.benelux@lifefitness.com
Operating Hours: 9.00h -17.00h (CET)

All Other EMEA countries & distributor business C-EMEA*

Bijdorplein 25-31
2992 LB Barendrecht
THE NETHERLANDS
Telephone: (+31) 180 646 666
Fax: (+31) 180 646 699
Service Email: service.db.cemea@lifefitness.com
Sales/Marketing Email:
marketing.db.cemea@lifefitness.com
Operating Hours: 9.00h-17.00h(CET)

ASIA PACIFIC (AP)

Japan

Life Fitness Japan

Nippon Brunswick Bldg., #8F
5-27-7 Sendagaya
Shibuya-Ku, Tokyo
Japan 151-0051
Telephone: (+81) 3.3359.4309
Fax: (+81) 3.3359.4307
Service Email: service@lifefitnessjapan.com
Sales/Marketing Email: sales@lifefitnessjapan.com
Operating Hours: 9.00h-17.00h (JAPAN)

China and Hong Kong

Life Fitness Asia Pacific LTD

Room 2610, Miramar Tower
132 Nathan Road
Tsimshatsui, Kowloon
HONG KONG
Telephone: (+852) 2891.6677
Fax: (+852) 2575.6001
Service Email: HongKongEnquiry@lifefitness.com
Sales/Marketing Email:
ChinaEnquiry@lifefitness.com
Operating Hours: 9.00h-18.00h

All Other Asia Pacific countries & distributor business Asia Pacific*

Room 2610, Miramar Tower
132 Nathan Road
Tsimshatsui, Kowloon
HONG KONG
Telephone: (+852) 2891.6677
Fax: (+852) 2575.6001
Service Email: HongKongEnquiry@lifefitness.com
Sales/Marketing Email:
ChinaEnquiry@lifefitness.com
Operating Hours: 9.00h-18.00h

* Also check www.lifefitness.com for local representation or distributor/dealer.

TABLE OF CONTENTS

Section	Description	Page
1.	Important Safety Instructions2
2.	Media Connections5
3.	Radio Frequency Interference (RFI)6
4.	Specifications7
5.	Quick Reference8
6.	Basic Functions	
	Life Fitness TV Remote9
	IR TV Remote10
	LCD Touch Screen12
	TV Side Panel & Front Panel Controls13
7.	Getting Started14
8.	Menus15
	Main On Screen Display (OSD)15
	Picture16
	Sound18
	Channel20
	Manager Control23
	Setup28
	Others30
9.	Maintenance and Troubleshooting31
10.	Warranty Information35

IMPORTANT SAFETY INSTRUCTIONS

- **DANGER:** To reduce the risk of electrical shock, always unplug this Life Fitness product before cleaning or attempting any maintenance activity.
- **WARNING:** To reduce the risk of burns, fire, electric shock, or injury, it is imperative to connect each product to a properly grounded electrical outlet.
- **WARNING:** To prevent injury, this product must be securely attached in accordance with the installation instructions.
- Never operate a Life Fitness product if it has a damaged power cord or electrical plug, or if it has been dropped, damaged, or even partially immersed in water. If this occurs, contact Life Fitness Customer Support Services as outlined in *Service* at the end of this manual.
- Position this product so that the AC power cord plug is accessible to the user.
- Keep the power cord away from heated surfaces. Do not pull the equipment by the power cord or use the cord as a handle.
- If the electrical supply cord is damaged, it must be replaced by the manufacturer, an authorized service agent, or a similarly qualified person to avoid a hazard.
- Do not use this product in areas where aerosol spray products are being used or where oxygen is being administered. Such substances create the danger of combustion and explosion.
- Always follow the product instructions for proper operation.
- Never insert objects into any openings of the Life Fitness product. If an object should drop inside, unplug this Life Fitness product and carefully retrieve it while the unit is not in use. If the object cannot be reached, contact Life Fitness Customer Support Services.
- Do not use this product outdoors, near swimming pools or in areas of high humidity. Do not expose this product to dripping or splashing liquids. If the product should be exposed to liquid, contact Life Fitness Customer Support Services.
- Never operate a Life Fitness product with the air openings blocked. Keep air openings free of lint, hair, or any obstructing material.
- Use this product only for its intended use as described in this manual. Do not use attachments that have not been recommended by the manufacturer.

SAVE THESE INSTRUCTIONS FOR FUTURE REFERENCE.

CONSIGNES DE SECURITE IMPORTANTES

- **DANGER:** Pour réduire les risques de décharge électrique, toujours débrancher cet appareil Life Fitness avant le nettoyage ou toute mesure d'entretien.
- **AVERTISSEMENT:** Pour réduire les risques de brûlures, d'incendies, de décharges électriques ou de blessures, chaque appareil doit absolument être branché sur une prise électrique correctement mise à la terre.
- **AVERTISSEMENT** Pour prévenir les blessures, ce produit doit être solidement fixé, conformément aux instructions d'installation.
- Ne jamais faire fonctionner un produit Life Fitness dont la fiche ou le cordon d'alimentation est endommagé, ni aucun appareil qui serait tombé ou aurait été endommagé ou même partiellement plongé dans l'eau. Si cela se produit, communiquer avec le service à la clientèle de Life Fitness de la manière indiquée à la rubrique Coordonnées des réparateurs agréés à la fin du présent guide.
- Placer l'appareil de façon à ce que l'utilisateur ait accès à la fiche du cordon d'alimentation.
- Tenir le cordon d'alimentation à l'écart de toute surface chauffée. Ne pas tirer l'appareil par le cordon d'alimentation; ne pas utiliser le cordon comme poignée.
- Si le cordon d'alimentation électrique est endommagé, il doit être remplacé par le fabricant, par un réparateur agréé ou par une personne qualifiée afin d'éviter tout danger.
- Ne pas utiliser ce produit dans des salles où des vaporisateurs aérosols sont employés ou bien où de l'oxygène est administré. Ces substances créent des risques de combustion et d'explosion.
- Toujours suivre les instructions sur le produit pour s'assurer de son fonctionnement adéquat.
- Ne jamais insérer aucun objet dans les ouvertures du produit Life Fitness. Si un objet tombe à l'intérieur du produit Life Fitness, le débrancher et extraire l'objet soigneusement pendant que l'appareil est débranché. S'il est impossible d'atteindre l'objet, communiquer avec le service à la clientèle de Life Fitness.
- Ne pas utiliser ce produit à l'extérieur, près d'une piscine ou dans des endroits très humides. Ne pas exposer ce produit à des liquides qui s'égouttent ni à des éclaboussures. Si le produit est en contact avec des liquides, communiquer avec le service à la clientèle de Life Fitness.
- Ne jamais faire fonctionner d'appareil Life Fitness dont les orifices d'aération seraient bloqués. Les garder exempts de peluches, de cheveux ou de toute obstruction.
- Utiliser ce produit uniquement pour les fins auxquelles il est destiné et de la manière décrite dans le présent manuel. Ne pas utiliser d'accessoires qui ne sont pas recommandés par le fabricant.

CONSERVER CES INSTRUCTIONS POUR TOUT USAGE ULTÉRIEUR.

IMPORTANT SAFETY INSTRUCTIONS

Note to the CATV Installer:

This reminder is provided to call the CATV system installer's attention to Article 820-40 of the NEC that provides guidelines for proper grounding and, in particular, specifies that the cable ground shall be connected to the grounding system of the building as close to the point of cable entry as practical.

Antenna Grounding According to the NEC

Antenna Grounding According to the National Electrical Code, ANSI/NFPA 70.

1. Antenna lead in wire
2. Antenna discharge unit (NEC Section 810-20)
3. Grounding conductors (NEC Section 810-21)
4. Ground clamp
5. Power service grounding electrode system (NEC Article 250, Part H)
6. Ground clamp
7. Electric service equipment

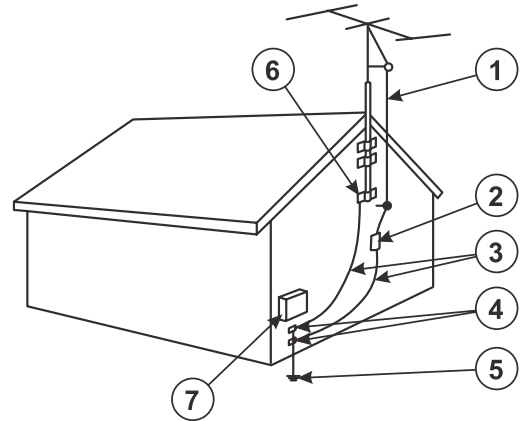

MEDIA CONNECTIONS

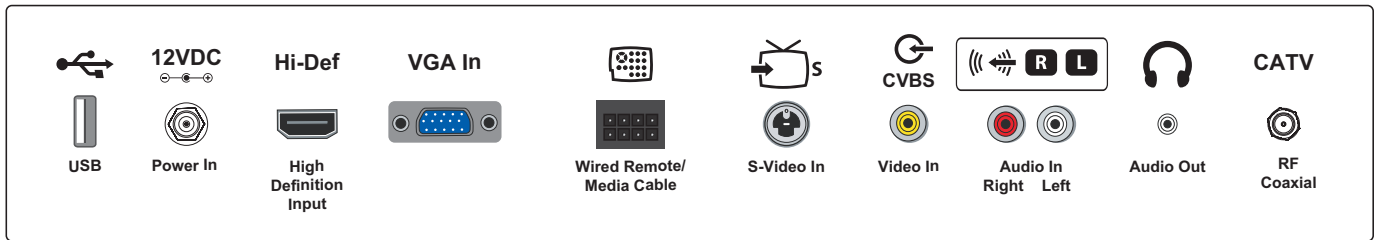

	Description	Connector Type
USB	USB Flash Drive	USB Type A
Power In	12 Volt DC Power In	Power Jack
High-Definition Input	High-Definition Audio & Video Connection	High-Definition
VGA In	PC-Video Connection	VGA
Wired Remote / Media Cable	Wired Remote Control Connection	Remote Control
S-Video In	S-Video Signal In	S-Video
Video In	Video In	RCA (yellow)
Audio In	Stereo Line In	RCA (red and white)
Audio Out	Headphone Connection	3.5mm stereo jack, 0.3W
RF Coaxial	Antenna / Cable Connection	RF F-Type

RADIO FREQUENCY INTERFERENCE

Note: This equipment has been tested and found to comply with the limits for a Class B digital device pursuant to Part 15 of the FCC Rules. These limits are designed to provide reasonable protection against harmful interference in a residential installation. This equipment generates, uses, and can radiate radio frequency energy and, if not installed and used in accordance with the instructions, may cause harmful interference with radio communications. However, there is no guarantee that interference will not occur in a particular installation. If this equipment does cause harmful interference to radio or television reception, which can be determined by turning the equipment off and on, the user is encouraged to try to correct the interference by one or more of the following measures:

- Re-orient or relocate the receiving antennas.
- Increase the separation between the equipment and receiver.
- Connect the equipment into an outlet on a circuit different from that to which the receiver is connected.
- Consult Life Fitness or an experienced radio/TV technician for help.



CAUTION: Any changes or modifications to this equipment could void the product warranty.

Mise en garde: tout changement ou toute modification de ce matériel peut annuler la garantie du produit.

Industry Canada

This Class B digital apparatus complies with Canadian ICES-003.

Cet appareil numérique de la classe B est conforme à la norme NMB-003 du Canada.

SPECIFICATIONS

17" Diagonal Wide Screen Format

Aspect Ratio: 16:9

Viewing Angle: 170 degrees horizontal x 170 degrees diagonal

HD Channel Ready: High-definition television

Visible Screen Size: 14.55" L x 8.73" H (37cm L x 22cm H)

Brightness: 450nits (cd/m²)

Display Color: 16.7 million

Resolution: 2.94 million pixels, 1280(H) x 768(V)WXGA

Contrast Ratio: 500:1

Video:

Composite, S-video, High-Definition, VGA, RF Analog TV Systems: NTSC, PAL-M, PAL-N

Digital Broadcasting System: ATSC

Audio (MTS): Mono, Stereo, and SAP

Channel Coverage: UHF, VHF, CATV

Antenna: RF: 75-ohm RF Input (+12dBmV +/- 25dB)

Power Requirements: 42W Nominal

External Power Supply: 12Vdc 5A

Power Rating:

AC Power Input: 100-240V ~ 50/60 Hz 1.5A

DC Supply Input: 12V ... 5A

Headphone Jack: 3.5mm Stereo, 300 milliwatt

Physical Dimensions:

Length: 17.3" (44cm)

Depth: 2.8" (7cm)

Height: 12.1" (31cm)

Weight: 17 lbs. (6.4kg)

Shipping Dimensions:

Length: 21" (53.3cm)

Depth: 7" (17.8cm)

Height: 15" (38.1cm)

Weight: 17 lbs. (7.7kg)

LCD Screen Length: 14.55" (37cm)

LCD Screen Height: 8.73" (23cm)

VESA Mounting Support: 75mm(H) x 75mm(W)

Attachable TV Warranty: 2-year limited warranty / electrical and mechanical parts; 90-day labor. Warranties outside the U.S may vary. Specifications subject to change.

QUICK REFERENCE

Action	LF TV Remote	IR (Infrared) TV Remote	Side Panel
Access Setup Menu	Press and Hold the POWER key for 5 Seconds.	Press MENU.	Press the MENU button.
Scroll Menu	Use the UP and DOWN arrow keys.	Use the UP and DOWN arrow keys.	Use the UP and DOWN channel arrow buttons.
Make a Selection	Press the CLOSED CAPTION (CC) button or the RIGHT VOLUME key.	Press ENTER.	Press the SOURCE button.
Go Back	Use the LEFT VOLUME key.	Press MENU.	Press the MENU button.
Exit Setup Menu	Press and Hold the POWER key for 5 seconds.	Press MENU or Press EXIT.	Press the MENU button.

BASIC FUNCTIONS OF LF TV REMOTE

BASIC FUNCTIONS

Turn the power on by pressing the ON/OFF key (1) on the remote control. A blue LED appears on the lower right corner of the TV when the power is on. The LED blinks during SLEEP mode (the back light will be off).

Press the POWER key (1) and hold for 5 seconds to access the Setup Menu.

Use the RIGHT VOLUME key (2) and LEFT VOLUME key (3) to adjust volume. The RIGHT VOLUME key (2) increases volume. The LEFT VOLUME key (3) decreases volume. A volume indicator will appear on the console while the volume is being adjusted. The volume indicator will disappear after approximately 20 seconds of inactivity.

Use the RIGHT VOLUME KEY (2) to select a menu option. Use the LEFT VOLUME key (3) to go backwards through menu options.

Channels can be selected by using the NUMERIC KEYPAD (4) or by scrolling up or down through available channels by pressing the UP and DOWN channel arrow keys (5).

Press the CLOSED CAPTION (CC) key (7) to turn the closed caption on/off.

Press the MUTE key (8) to mute the sound.

The PREVIOUS key (9) can be used to select the channel viewed immediately prior to the current channel. Repeatedly pressing the PREVIOUS key can be used to toggle between two channels.

Note: The PREVIOUS key (9) acts as the "-" when entering channels. Example: Press "5", "PREVIOUS key", "1" to enter 5-1 as the channel.

Headphones are necessary to hear any volume adjustments. Plug headphones into the HEADPHONE JACK (6) located on the side of the remote control.

Within Set-Up Menus:

Use the RIGHT VOLUME key (2) to select a menu option. Use the LEFT VOLUME key (3) to go backwards through menu options.

Use the CC key (7) to select menu options.

Use the CC key (7) as the ENTER function when selecting channels.

Note: The Achieve™ console with Attachable TV includes the LF TV Remote. The Attachable TV System for new or previously purchased Life Fitness silver/gray commercial cardio machines includes the LF TV Remote.

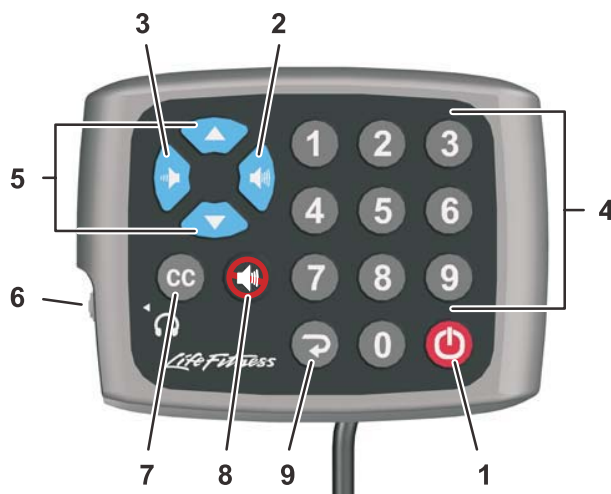

BASIC FUNCTIONS - IR TV REMOTE

IR TV REMOTE

IR TV Remote - Programming is easier with the optional IR TV remote. Contact Life Fitness (see page one for information) to order one or more IR TV remote controls if desired.

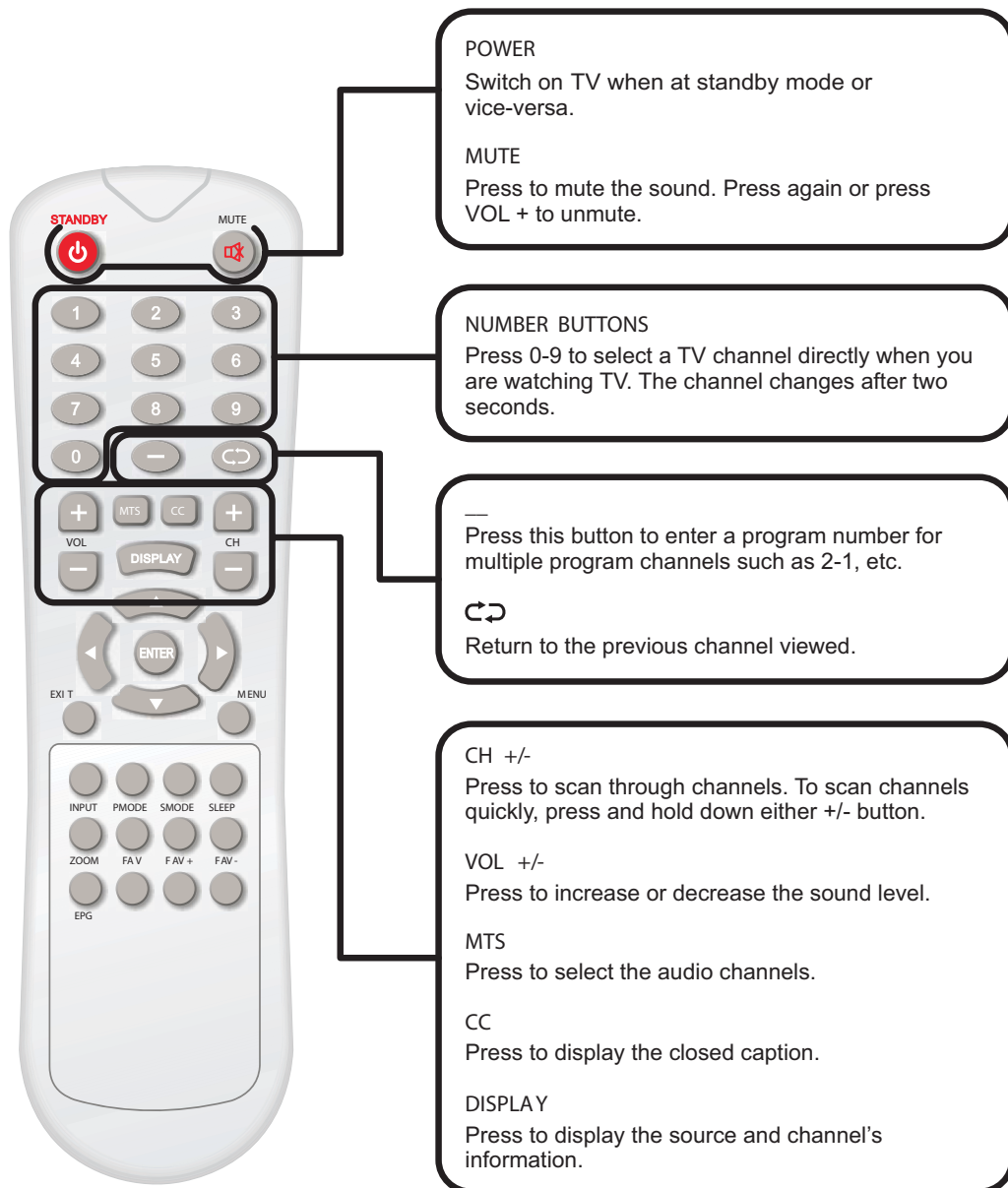

BASIC FUNCTIONS - IR TV REMOTE

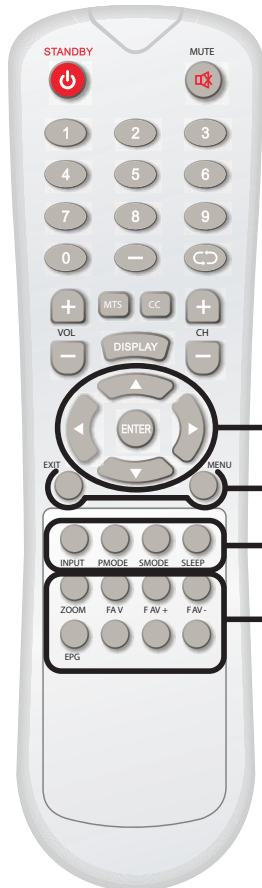

THUMBSTICK (▲/▼/◀/▶/ENTER)
Allows you to navigate the on-screen menus and adjust the menu settings to your preference.

EXIT
Clears all on-screen displays and returns to TV viewing from any menu.

MENU
Brings up the main menu to the screen.

INPUT
Press to cycle through the input source in following: RF Composite VGA High Definition S-VIDEO

PMODE
Press repeatedly to cycle through the available video picture modes (User, Dynamic, Standard, Movie).

SMODE
Press to cycle through the different sound settings (Concert, Voice, Jazz, User).

SLEEP
Lets you select amount of time before your TV automatically turns off the LCD backlight

ZOOM
Enlarges the main picture size. Press to cycle through screen sizes (Water Glass, Cinema, Wide, Normal).

FAV
Press to add or remove favorite channel.

FAV+
Press to increase the program





FAV-
Press to decrease the program

EPG
Press to enter the EPG menu directly.

IR TV REMOTE

Two 1.5V-AAA batteries are included and necessary for operation.

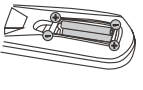
Installing Batteries

<p>1 Open the battery compartment cover on the back side.</p>		<div data-bbox="1053 1691 1189 1803" style="text-align: center;">  </div> <ul style="list-style-type: none"> ✦ Point the remote towards the remote control sensor of the wireless TV and use it within 7 meters. ✦ Put the used batteries into the recycling bin since it can negatively affect the environment.
<p>2 Insert two 1.5V AAA size batteries in correct polarity. Don't mix old or used batteries with new ones.</p>		
<p>3 Close the cover.</p>		

LCD TOUCH SCREEN

LCD TOUCH SCREEN

The Life Fitness Elevation™ Series with the Inspire™ Console has the TV controls built-in the integrated LCD touch screen. TV controls include power, channel up/down, numeric keypad, mute, and previous channel.

Note: Closed Caption (CC) and Secondary Audio Programming (SAP) are available in select countries.



BASIC FUNCTION - TV SIDE PANEL & FRONT PANEL CONTROLS

TV SIDE PANEL



POWER Power on / off.

SOURCE Select the input signal source.
Use as "ENTER" function when in On Screen Display (OSD).

MENU Press once to display the OSD.
Press again to turn the OSD off.

CHANNEL Change the channels.
Use the UP and DOWN channel arrow buttons to scroll through menu options.

VOLUME Adjust the volume.
Use the UP VOLUME arrow button to move right when scrolling through options.
Use the DOWN VOLUME arrow button to move left when scrolling through options.

TV FRONT PANEL



TV ON - Blue LED On

TV OFF - Blue LED Off

SLEEP MODE - Blue LED Blinks

GETTING STARTED

SELECT SIGNAL CONFIGURATION

After you install the Life Fitness Attachable TV and have connected all the power and cable or antenna, turn the TV ON. **You must select a signal configuration based on your location before continuing.**

1. Press the LEFT VOLUME key on the LF TV Remote to display the volume indicator.
2. Hold the LEFT VOLUME key down until the volume indicator reaches zero.
3. Type 9875 using the numeric keypad.
4. Scroll through the TV System Select menu options in the upper left hand using the UP and DOWN arrow keys on the LF TV Remote.
5. Select the desired option and press ENTER.
 - ATSC + NTSC (Digital and Analog - U.S. This is the Default Setting)
 - PAL-M + PAL-N (Analog - Brazil, Argentina, and Uruguay)
6. Press the RIGHT VOLUME arrow key to perform a channel search.
Note: A signal source must be connected to do a channel search.
7. Press the DISPLAY key. Details of the current channel will be shown.

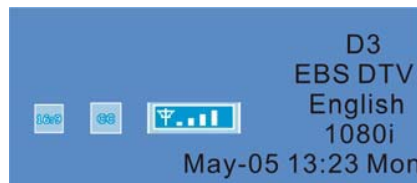

8. Press the MENU key. Input password to enter the Main On Screen Display (OSD).
Note: The factory default password is "0000". Password can be changed in the Manager Control Menu.

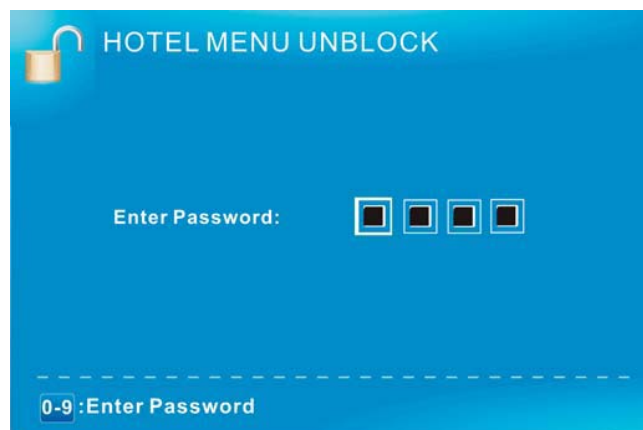

MAIN ON SCREEN DISPLAY (OSD)



Menu Navigation:

- Press MENU to display the Main On Screen Display (OSD).
- Use LEFT and RIGHT arrow keys to select desired menu.
- Press ENTER to enter the sub-menus.
- Use the UP and DOWN arrow keys to select the sub-menu option.
- Use the LEFT and RIGHT arrow keys to adjust the values in the sub-menu options.
- Press MENU to return to the upper menu.
- Press EXIT to close the OSD.

Main Menus	Sub-Menus
Picture	<ul style="list-style-type: none"> • Picture Settings • Screen Settings • PC Settings • Color Temperature • Advanced Picture Settings
Sound	<ul style="list-style-type: none"> • Sound Settings • Preferred Analog Sound • Preferred Audio Language • Other Settings • Equalizer Settings
Channel	<ul style="list-style-type: none"> • Channel List • Favorite List • Manual Channel Setting • Signal Type • Auto Channel Search • Channel Lock
Manager	<ul style="list-style-type: none"> • V-Chip • Change Password • Clear Channel • Hotel Menu
Setup	<ul style="list-style-type: none"> • Closed Caption • Menu Language • Sleep Timer • Clock

PICTURE MENU

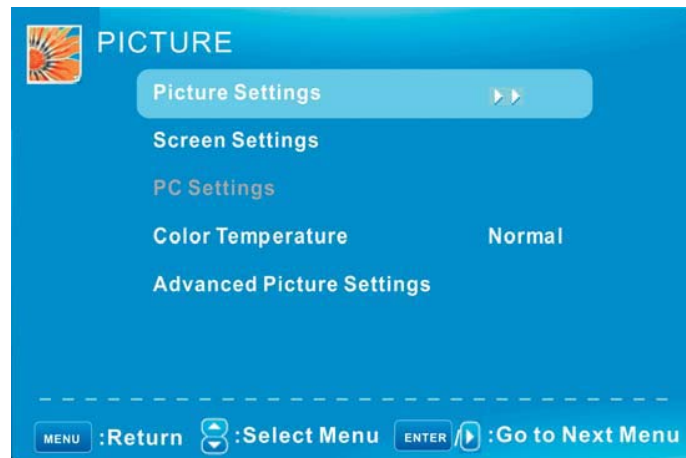

Menu Navigation:
 Use UP and DOWN arrow keys to select desired menu item.
 Use LEFT and RIGHT arrow keys to adjust menu items.

Picture Settings

Available Picture Modes:

- *Movie, User, Dynamic, Standard*

Brightness, Contrast, Color, Tint, Sharpness:

- *Adjust Brightness, Contrast, and Color levels from 0 to 50.*
- *Adjust Tint level from -25 to +25.*
- *Adjust Sharpness level from 0 to 25.*

Note: *Brightness, Contrast, Color, Tint, and Sharpness can only be adjusted in the USER MODE.*

Screen Settings

Available Screen Sizes:

- *Water Glass, Cinema, Wide, Normal*

Auto Wide:

- *Sets the picture to automatically fit the broadcasters' formats. A checkmark will appear in the box when Auto Wide is selected.*

PICTURE MENU - CONTINUED

Menu Navigation:

Use UP and DOWN arrow keys to select desired menu item.
Use LEFT and RIGHT arrow keys to adjust menu items.

Color Temperature

Available Color Temperatures:

- *Cool, Normal, Warm*



Advanced Picture Settings

Dynamic Contrast:

Adjust the contrast corresponding to the input signal in order to improve the picture quality.

- *On / Off*

Film Mode:

- *On / Off (handles 3:2 and 2:2 pull down)*

Noise Reduction:

- *Low, Medium, Off, High*

MPEG Noise Reduction:

Improve the picture quality by reducing the block noise.

- *Low, Medium, Off, High*



SOUND MENU



Menu Navigation:
Use UP and DOWN arrow keys to select desired menu item.
Use LEFT and RIGHT arrow keys to adjust menu items.

Sound Settings	
	<p>Available Sound Modes:</p> <ul style="list-style-type: none">• <i>User, Concert, Voice, Jazz</i> <p>Bass, Treble, Balance:</p> <ul style="list-style-type: none">• <i>Adjust Bass level from -15 to +15.</i>• <i>Adjust Treble level from -15 to +15.</i>• <i>Adjust Balance level from -25 to +25.</i>
Preferred Analog Sound	
<p>Available Preferred Analog Sounds:</p> <ul style="list-style-type: none">• <i>SAP, Stereo, Mono</i>	
Preferred Audio Language	
<p>Available Preferred Audio Languages:</p> <ul style="list-style-type: none">• <i>English, French, Spanish</i>	

SOUND MENU - CONTINUED

Menu Navigation:

- Use UP and DOWN arrow keys to select desired menu item.
- Use LEFT and RIGHT arrow keys to adjust menu items.
- Use LEFT and RIGHT arrow keys to Enable / Disable.

Other Settings

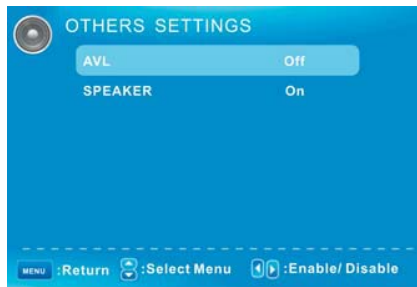

AVL (Auto Volume Level):

- On / Off

Speaker

- On / Off

Equalizer Settings



Available Equalizer Modes:

- Pop, User, Off, Rock, Jazz

CHANNEL MENU



Menu Navigation:

Use UP and DOWN arrow keys to select desired menu item.
Use LEFT and RIGHT arrow keys to adjust menu items.
Press ENTER to go to the sub-menus.

Channel List



- Use the UP and DOWN arrow keys to scan the Channel List.
- Use the LEFT and RIGHT arrow keys to go to the next page.
- If certain channels are set to be locked, the lock logo icon will be displayed.

Favorite List



- Use the UP and DOWN arrow keys to scan the Favorite Channel List.
- Use the LEFT and RIGHT arrow keys to go to the next page.

Note: The Channel Menu is displayed ONLY when “TV” is the selected input source and the Tuner Lock is set to “OFF”.

CHANNEL MENU - CONTINUED

Menu Navigation:

Use UP and DOWN arrow keys to select desired menu item.
Use LEFT and RIGHT arrow keys to adjust menu items.
Press ENTER to go to the sub-menus.

Manual Channel Setting List



- Use the LEFT and RIGHT arrow keys to select the channel number or press the numeric keys to select the channel you want to set.



- Press ENTER to add or delete the current channel in the Channel List.



- Use the LEFT and RIGHT arrow keys to set the Channel Label.
- Press ENTER to save the setting.



- Press ENTER to add or delete the current channel in the Favorite Channel List.

CHANNEL MENU - CONTINUED

Menu Navigation:

Use UP and DOWN arrow keys to select desired menu item.
Use LEFT and RIGHT arrow keys to adjust menu items.

Signal Type



Available Signal Types:

- *Air, Cable, and Air + Cable*

Auto Channel Search

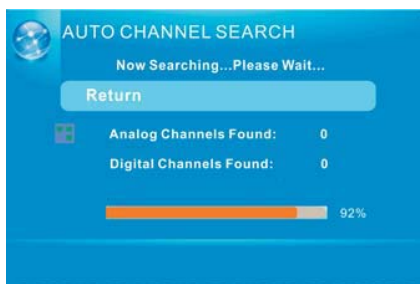

Auto Channel Search:

- When the video system is set to NTSC/PAL-M +PAL-N, the Digital Channels Found option is gray.

Channel Lock

Press ENTER to set the Channel Lock.
You will not be able to enter the locked channel after setting the channel lock.

MANAGER CONTROL MENU

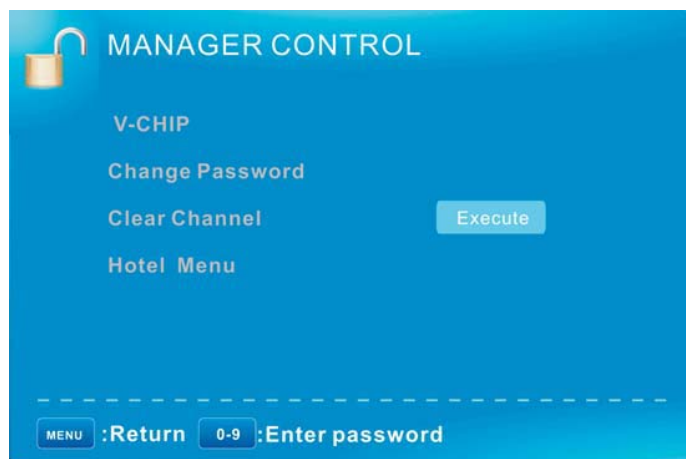

Menu Navigation:

Use UP and DOWN arrow keys to select desired menu item.
Use LEFT and RIGHT arrow keys to adjust menu items.
Press ENTER to go to sub-menus.
Press ENTER to Lock.

V-Chip



V-Chip:

- *US V-Chip*
- *Canada V-Chip*
- *Block UnRated Show*



USA:

- *Movie Rating*
- *TV Rating*



Movie Rating:

- *Use the UP and DOWN arrow keys to select the Movie Rating.*
- *Press ENTER to lock.*

MANAGER CONTROL MENU - CONTINUED

Menu Navigation:

- Use UP and DOWN arrow keys to select desired menu item.
- Use LEFT and RIGHT arrow keys to adjust menu items.
- Press ENTER to go to sub-menus.
- Press ENTER to Lock.

V-Chip



TV Rating:

- Use the UP and DOWN arrow keys to select the TV rating.
- Press ENTER to lock.



Canada V-Chip:

- Similar to US V-Chip.
- English Rating
(C, C8+, G, PG, 14+, 18+)
- French Rating
(G, 8 ans+, 13 ans+, 16ans+, 18 ans+)



Block UnRated Show:

- Press ENTER to block.

Downloadable Rating:

- Press ENTER to set rating.

Note: If the DTV program does not have this rating information, this option will be grayed out.

Clear Downloadable Rate:

- Press ENTER to set rating.

MANAGER CONTROL MENU - CONTINUED

Menu Navigation:

Use UP and DOWN arrow keys to select desired menu item.
Use LEFT and RIGHT arrow keys to adjust menu items.
Press ENTER to go to sub-menus.

Change Password



Change Password:

- Enter a password using the numeric keys.

Note: If you forget your password, input “1470” to enter locked menus.

Clear Channel List

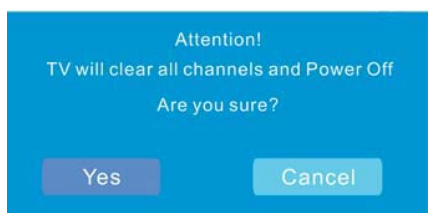

Clear Channel List:

- After selecting “YES”, the TV will power off and all channels will be cleared.
- After selecting “Cancel”, the Manager Control Menu will be displayed.

Hotel Menu



Hotel Menu:

- After entering the Hotel Menu, additional sub-menus are displayed.

Please refer to following page for descriptions.

MANAGER CONTROL MENU - CONTINUED

Menu Navigation:

Use UP and DOWN arrow keys to select desired menu item.

Use LEFT and RIGHT arrow keys to change settings.

Hotel Settings - Boot Settings

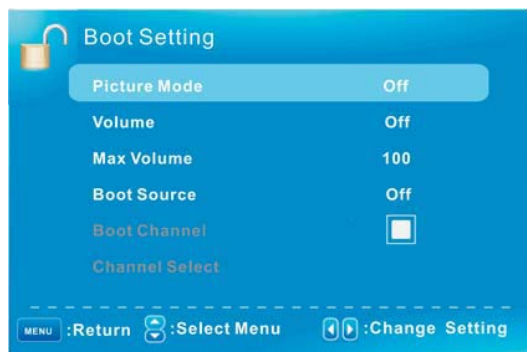

Available Picture Modes:

- Off, Dynamic, Standard, Movie, User

Note: The Picture Mode selected will be on when the TV is turned On. If "Off" is the desired selection, the last mode selected before turning off the TV will come on.

Volume Levels:

- 0 to 100

Max Volume Levels:

- 0 to 100

Note: After the Max Volume Level is set, the volume cannot be adjusted above the selected level.

Available Boot Sources:

- TV, AV, S Video, Hi-Def, PC, Off

Note: If "Off" is the desired selection, the default source will be the last source selected before turning off the TV.

Boot Channel:

- TV, AV, S Video, Hi-Def, PC, Off

Note: "TV" must be selected as the Boot Source before setting Boot Channel.

Channel Select:

- Set the default channel.

Note: Boot Channel has to be selected before setting Channel Select.

MANAGER CONTROL MENU - CONTINUED

Menu Navigation:

Use UP and DOWN arrow keys to select desired menu item.
Use LEFT and RIGHT arrow keys to change settings.
Press ENTER to Enable / Disable.

Hotel Lock Settings



KeyPad Lock:

- The keyboard will not function if the Key Pad Lock is enabled.

Menu Lock:

- Menu is password protected when locked.

Source Lock:

- The locked source cannot be entered if the lock is enabled.

Other Hotel Settings



Power Save:

- Use the LEFT and RIGHT arrow keys to set the time the TV will automatically power off .

Export Setting:

Note: A USB flash drive must be inserted before data can be exported.

Import Setting:

Note: A USB flash drive must be inserted before data can be imported.

Reset Hotel Setting:

- After selecting "YES", the Hotel Settings will be cleared.

- After selecting "Cancel", the Hotel Settings Menu will be displayed.

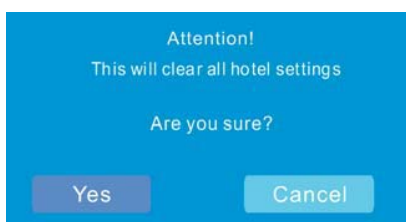

SETUP MENU



Menu Navigation:

Use UP and DOWN arrow keys to select desired menu item.
Use LEFT and RIGHT arrow keys to adjust menu items.

Closed Caption



Caption Display:

- On / Off

Available Analog Caption Types:

- Text1, Text2, Text3, Text4, CC1, CC2, CC3, CC4

Available Digital Caption Types:

- Service 1 -6

Digital CC Preset:

- Default, Custom

Digital CC Style sub menu is shown only when Digital CC Preset is set to "Custom".



Available CC Sizes:

- Small, Standard, Large, Default

Available CC Fonts:

- Styles 1 -7

Available CC Opacities:

- Flashing, Default, Solid, Translucent, Transparent

Available Text Colors:

- Blue, Yellow, Red, Black, White, Green, Magenta, Cyan, Default

Available CC Background Opacities:

- Flashing, Default, Solid, Translucent, Transparent

Available CC Background Colors:

- Blue, Yellow, Red, Black, White, Green, Magenta, Cyan, Default

SETUP MENU - CONTINUED

Menu Navigation:

Use UP and DOWN arrow keys to select desired menu item.
Use LEFT and RIGHT arrow keys to adjust menu items.

Menu Language



Available Menu Languages:

- English, French, Spanish

Sleep Timer



Sleep Timer:

- Use RIGHT and LEFT arrow keys to set the time before the TV is automatically powered off.
- Choose between 0 - 240 minutes (in 10-minute increments).
- After setting the Sleep Timer, the Time remaining will be displayed this menu.
- The blue light on the front panel of the TV will stay lit after the Sleep Timer activates.
- Press any button to wake up the TV.

Clock



Available Time Zones:

- Central, Mountain, Pacific, Alaska, Hawaii, Samoa, Newfoundland, Atlantic, Eastern

Auto Clock:

- On / Off

Setup Time:

- Use RIGHT and LEFT arrow keys to adjust the time. Press ENTER to go to next option.

Day of Week:

- Displays the Day of the Week corresponding to the Setup Time.

OTHERS MENU



Menu Navigation:

Use UP and DOWN arrow keys to select desired menu item.
Use ENTER to adjust menu items to ON /OFF.

Others Settings

Blue Background:

- Press *ENTER* to select the *Blue Background*.

No Signal Power Off:

- *On / Off*
- *The TV shuts off without a proper signal source connected. The blue light on the front panel of the TV will stay lit. Press any button to wake up the TV.*

Reset Settings:

- *Reset all options.*
- *Use the LEFT or RIGHT arrow keys to select "YES" or "CANCEL".*

Attention!
This will clear all hotel settings
Are you sure?

Yes Cancel

MAINTENANCE & TROUBLESHOOTING

The Life Fitness Attachable TV System requires little maintenance and has been designed to withstand the environment of a fitness facility. However, please review our suggestions on cleaning and troubleshooting your Life Fitness Attachable TV System.

CLEANING

Regularly (*at least once a week*) clean the Life Fitness Attachable TV and cardio equipment using mild soap and water. Lightly dampen a soft clean cloth with the mild soap and water solution and wipe the product. Do not use too much solution on the cloth and do not spray or pour any solution directly on the products. Doing so could cause damage to the LCD panel or remote controls.

Caution: Do not use liquid cleaners or aerosol cleaners to clean the screen. Do not use any solvents such as alcohol and paint thinner or acidic cleaners.

TROUBLESHOOTING

If you are having a problem with your TV, try the suggestions below and on the next several pages. If the problem persists, contact Life Fitness Customer Support Services as outlined in the front of this manual.

Problem	Possible Solutions
Reset the TV to factory settings	Refer to the Manager Control Menu for instruction on how to access the Reset option.
No picture, no sound	Make sure the power cord is plugged in. Be sure the power is on by pressing the on/off button on the remote control. Choose an alternate channel using the channel up/down arrow keys.
Poor or no picture, good sound	Refer to the Picture Menu. Adjust the options as instructed to improve the picture quality. Check the antenna and/or cable connections. Have your service provider confirm that the signal level at the machine is 72 dBuV + / - 25 dB. This is equivalent to +12 dBmV, and includes the range of -13 dBmV to +37dBmV. These levels are acceptable for both analog and digital TV signals.
Good picture, no sound	Press the volume up key on the IR TV remote control or side panel or press the right volume key on the LF TV remote control. (Headphones are required to hear sound.)
No color	Check the antenna and/or cable connections. Confirm the correct color format is selected. Refer to the System Setup section for instruction on how to access the country option within the TV Install Menu. Refer to Main On Screen Display Menu on how to access the Picture Menu. Adjust the Brightness, Contrast, Color, Tint, and Sharpness options as to improve the picture quality.
Only snow appears on the screen	Check the antenna and/or cable connections. Make sure the channel selected is currently broadcasting. Confirm the correct Air/Cable option is selected. Refer to the Channel Menu.
Dotted lines or stripes	Adjust the antenna. Move the TV away from other electronic equipment. Some electronic equipment creates electrical noise, which can interfere with TV reception.
Double images or ghosts	Check your outdoor antenna or call your cable service.
Unable to switch to a particular	Confirm the correct Air/Cable option is selected. Refer to the Channel Menu. Perform a Scan Channel or add a channel manually. Refer to the Channel Menu.

MAINTENANCE & TROUBLESHOOTING

Problem	Possible Solutions
Screen does not turn on	<p>Check the power supply for 12 volts DC and replace if faulty.</p> <p>Remove the remote and test it against a working unit. Replace if faulty.</p> <p>Replace TV.</p>
Channels do not change	<p>Rerun.</p> <p>Remove the remote and test against the working unit. Replace if faulty.</p> <p>Replace TV.</p>
Sound does not change	<p>Remove the remote and test it against the working unit. Replace if faulty.</p> <p>Replace TV.</p>
No sound	<p>Replace headphones.</p> <p>Replace headphone jack.</p> <p>Remove the remote and test it against the working unit. Replace if faulty.</p> <p>Replace TV.</p>
Unable to receive any channels when using cable	<p>Follow the install and setup procedures in the Installation Instructions.</p> <p>Replace Coax Cable (75 Ohms).</p> <p>Replace TV.</p>
Snow and noise appear on screen	<p>Follow the install and setup procedures in the Installation Instructions.</p> <p>Replace Coax Cable (75 Ohms).</p> <p>Replace TV.</p>
Some channels, or no channels, found after a channel scan.	<p>Check connections at wall plugs and where cables connect with the TV (and other devices such as VCRs, DVD players, etc.)</p> <p>Replace cables, connectors, outlets, and splitters with high quality components, Quad Shield coaxial cables, and "F" connectors.</p>

MAINTENANCE & TROUBLESHOOTING

ADVANCED TROUBLESHOOTING

If the picture regularly breaks up, then the signal received may be too weak or too strong to allow the digital TV receiver to generate a stable picture.

Have your service provider confirm that the signal level at the machine is 72 dBuV + / - 25 dB. This is equivalent to +12 dBmV, and includes the range of -13 dBmV to +37dBmV. These levels are acceptable for both analog and digital TV signals.

If signal levels are not OK, you are unlikely to have good reception unless signal strength can be improved - antenna relocation or changes to your amplifiers (masthead or distribution) may be indicated.

Remember amplifiers should only be used by your installer to provide the minimum necessary boost to signal strength

Interference from impulse noise may be causing pictures to break up and audio to drop out momentarily.

Check for domestic sources of impulse noise (i.e. the use of light switches, fridges, hair dryers, air conditioner, etc.).

If present, arrange for all cables, connectors, outlets and splitters between the antenna and the receiver to be upgraded in accordance with antenna installation guidelines. Recommends the use of quad shielded coaxial cable and F connectors.

A masthead amplifier may have boosted the signal outside the receiver's "operating window", making reception impossible.

The masthead amplifier (appears as a small box on the antenna pole within about a meter of the antenna arms) may be able to be turned down - if your antenna is on your roof you should arrange for an antenna installer to perform this task.

When digital broadcasting services begin operating in an area some masthead amplifiers (boosters) operating at maximum output or maximum gain may need to be turned down to avoid signal overload for digital receivers. This matter should be determined by an antenna installer, who will be able to adjust the amplifier for you.

Please note that performing this operation may affect any existing analog signals, so you **MAY** need to find a medium point between adequate analog reception and good digital reception.

MAINTENANCE & TROUBLESHOOTING

REPLACING HEADPHONE JACK ON THE WIRED REMOTE CONTROL

Check the headphone jack when you cannot hear audio or the audio quality is poor. The headphone jack is designed to be easily and quickly replaced in the facility.

1. Take out headphone jack.
2. Disconnect audio cable.
3. Slide the stereo plug on the audio cable in the new headphone jack.
4. Replace the headphone jack.

IMPORTANT: *Do not stretch, crimp or damage the cable. Cables damaged by improper installation will not be covered by the warranty.*

SERVICE

Any service, other than cleaning or user maintenance, must be performed by an authorized service representative. There are no user serviceable parts.

For information about product service or operation, please contact Life Fitness Customer Service.

IMPORTANT: *Do not attempt to service any of the Attachable TV System products except the service described in this manual.*

RETURNING EQUIPMENT TO LIFE FITNESS

To return equipment to Life Fitness for any reason, you must contact Life Fitness to obtain a return maintenance authorization (RMA) number (*see page one for contact information*). When you request an RMA number, please explain why you are returning the equipment.

IMPORTANT: *Equipment must be shipped with an RMA number in order for Life Fitness to process the return. Any equipment received without an RMA number will be returned to the sender.*

WARRANTY INFORMATION

WHAT IS COVERED:

This **Life Fitness** commercial exercise equipment ("*Product*") is warranted to be free of all defects in material and workmanship.

WHO IS COVERED:

The original purchaser or any person receiving the Product as a gift from the original purchaser.

HOW LONG IS IT COVERED:

All coverage is provided by specific Product according to the guidelines listed on the chart accompanying this warranty card.

WHO PAYS TRANSPORTATION & INSURANCE FOR SERVICE:

If the Product or any covered part must be returned to a service facility for repairs, **We, Life Fitness**, will pay all transportation and insurance charges for the first year. **You** are responsible for transportation and insurance charges during the second and third years (if applicable).

WHAT WE WILL DO TO CORRECT COVERED DEFECTS:

We will ship to you any new or rebuilt replacement part or component, or, at our option, replace the Product. Such replacement parts are warranted for the remaining portion of the original warranty period.

WHAT IS NOT COVERED:

Any failures or damage caused by unauthorized service or removal of parts, misuse, accident, negligence, improper assembly or installation, installation of external devices, debris resulting from any construction activities in the Product's environment, rust or corrosion as a result of the Product's location, alterations or modifications without our written authorization or by failure on your part to use, operate and maintain the Product as set out in your User Manual ("*Manual*").

All terms of this warranty are void if this product is moved beyond the continental borders of the United States of America (excluding Alaska, Hawaii and Canada) and are then subject to the terms provided by that country's local authorized Life Fitness representative.

WHAT YOU MUST DO:

Retain proof of purchase (*our receipt of the attached registration card assures registration of purchase information but is not required*); **use, operate and maintain** the Product as specified in the Manual; **notify** Customer Support Services of any defect within 10 days after discovery of the defect; if instructed, **return** any defective part for replacement or, if necessary, the entire Product for repair. Always retain proof of purchase, such as your bill of sale.

USER MANUAL:

It is **VERY IMPORTANT THAT YOU READ THE MANUAL** before operating the Product. Remember to perform the periodic maintenance requirements specified in the Manual to assure proper operation and your continued satisfaction.

HOW TO GET PARTS & SERVICE:

Simply call Customer Support Services (*listed on page one of this manual*) and tell them your name, address and the serial number of your Product. They will tell you how to get a replacement part, or, if necessary, arrange for service where your Product is located or advise you on how and where to ship the Product for service.

Before shipping:

1. **obtain** a Return Authorization Number (**RA#**) from Customer Support Services
2. securely **pack** your Product (*use the original shipping carton, if possible*)
3. **write** the **RA#** on the outside of the carton
4. **insure** the Product, and
5. **include** a letter explaining the defect or problem and a copy of your proof of purchase if you believe the service is covered by warranty

EXCLUSIVE WARRANTY:

THIS LIMITED WARRANTY IS IN LIEU OF ALL OTHER WARRANTIES OF ANY KIND EITHER EXPRESSED OR IMPLIED, INCLUDING BUT NOT LIMITED TO THE IMPLIED WARRANTIES OF MERCHANTABILITY AND FITNESS FOR A PARTICULAR PURPOSE, AND ALL OTHER OBLIGATIONS OR LIABILITIES ON OUR PART. We neither assume nor authorize any person to assure for us any other obligation or liability concerning the sale of this Product. Under no circumstances shall we be liable under this warranty, or otherwise, of any damage to any person or property, including any lost profits or lost savings, for any special, indirect, secondary, incidental or consequential damages of any nature arising out of the use of or inability to use this Product. Some states do not allow the exclusion or limitation of implied warranties or of liability for incidental or consequential damages, so the above limitations or exclusions may not apply to you.

CHANGES IN WARRANTY NOT AUTHORIZED:

No one is authorized to change, modify or extend the terms of this limited warranty.

EFFECT OF STATE LAWS:

This warranty gives you specific legal rights and you may have other rights which vary from state to state.

OUR PLEDGE TO YOU:

Our Products are designed and manufactured to the highest standards.

We want you completely satisfied with our Products and will do everything possible under the terms of this warranty to keep you secure in knowing you have bought the best!

